

XFP-10GB-CW57-80-I-PRO

MSA and TAA Compliant 10GBase-CWDM XFP Transceiver (SMF, 1570nm, 80km, DOM, -40 to 85C, LC)

Features

- INF-8077i Compliance
- Duplex LC Connector
- Industrial Temperature -40 to 85 Celsius
- Single-mode Fiber
- Hot Pluggable
- Excellent ESD Protection
- Metal with Lower EMI
- RoHS Compliant and Lead Free



Applications:

- 10x Gigabit Ethernet over CWDM
- 8x/10x Fibre Channel
- Access, Metro and Enterprise
- Mobile Fronthaul CPRI/OBSAI

Product Description

This MSA Compliant XFP transceiver provides 10GBase-CWDM throughput up to 80km over single-mode fiber (SMF) using a wavelength of 1570nm via an LC connector. It is built to MSA standards and is uniquely serialized and data-traffic and application tested to ensure that they will integrate into your network seamlessly. Digital optical monitoring (DOM) support is also present to allow access to real-time operating parameters. This transceiver is Trade Agreements Act (TAA) compliant. We stand behind the quality of our products and proudly offer a limited lifetime warranty.

Proline's transceivers are RoHS compliant and lead-free.

TAA refers to the Trade Agreements Act (19 U.S.C. & 2501-2581), which is intended to foster fair and open international trade. TAA requires that the U.S. Government may acquire only "U.S. – made or designated country end products.



Regulatory Compliance

- ESD to the Electrical PINs: compatible with MIL-STD-883E Method 3015.7.
- ESD to the Duplex LC Receptacle: compatible with IEC 61000-4-2
- Immunity compatible with IEC 61000-4-3.
- EMI compatible with FCC Part 15 Class B EN55022 Class B (CISPR 22B) VCCI Class B.
- Laser Eye Safety compatible with FDA 21CFR 1040.10 and 1040.11 EN60950, EN (IEC) 60825-1,2.
- RoHS compliant with 2002/95/EC 4.1&4.2 2005/747/EC.

CWDM Available Wavelengths

Wavelengths	Min.	Typ.	Max.
1270	1264.5	1271	1277.5
1290	1284.5	1291	1297.5
1310	1304.5	1311	1317.5
1330	1324.5	1331	1337.5
1350	1344.5	1351	1357.5
1370	1364.5	1371	1377.5
1390	1384.5	1391	1397.5
1410	1404.5	1411	1417.5
1430	1424.5	1431	1437.5
1450	1444.5	1451	1457.5
1470	1464.5	1471	1477.5
1490	1484.5	1491	1497.5
1510	1504.5	1511	1517.5
1530	1524.5	1531	1537.5
1550	1544.5	1551	1557.5
1570	1564.5	1571	1577.5
1590	1584.5	1591	1597.5
1610	1604.5	1611	1617.5

Absolute Maximum Ratings

Parameter	Symbol	Min.	Max.	Unit
Maximum Supply Voltage	Vcc3	-0.5	4.0	V
	Vcc5	-0.5	6.0	
Storage Temperature	TS	-40	85	°C
Operating Humidity	RH	5	85	%
Case Operating Temperature	Tc	-40	85	°C
50/125µm MMF (OM3)	Lmax		70	km

Electrical Characteristics (TOP=25°C, Vcc=3.3Volts)

Parameter	Symbol	Min.	Typ.	Max.	Unit	Notes
Power Supply Voltage	Vcc3	3.13	3.30	3.47	V	
	Vcc5	4.75	5.0	5.25		
Power Supply Current	Icc3			750	mA	
	Icc5			500		
Transmitter						
Differential data input swing	Vin,pp	120	600	850	mV	
Input differential impedance	Zin	90	100	110	Ω	
Receiver						
Differential data output swing	Vout, pp	300	600	850	mV	
Output differential impedance	Zin	90	100	110	Ω	
Transceiver						
Ref-clk input swing	Ref,pp	400		2400	mV	
TX Disable-High		2.0		Vcc+0.3	V	
TX Disable-Low		Vee-0.3		0.8	V	
LOS-High		2.0		Vcc+0.3	V	
LOS-Low		Vee-0.3		0.8	V	
MOD_DESEL-High		2.0		Vcc+0.3	V	
MOD_DESEL-Low		Vee-0.3		0.8	V	
MOD_INT-High		2.0		Vcc+0.3	V	
MOD_INT-Low		Vee-0.3		0.8	V	
MOD_NR-High		2.0		Vcc+0.3	V	
MOD_NR-Low		Vee-0.3		0.8	V	
P_DOWN/RST-High		2.0		Vcc+0.3	V	
P_DOWN/RST-Low		Vee-0.3		0.8	V	

Notes:

1. Maximum total power value is specified across the full temperature and voltage range and the inrush current is included.

Optical Characteristics

Parameter	Symbol	Min.	Typ.	Max.	Unit	Notes
Transmitter						
Operating Data Rate		9.95		11.3		
Output Opt. Power	PO	0		4	dBm	
Center Wavelength Spacing			100		GHZ	
Optical Wavelength	λ	$\lambda-6.5$	λ	$\lambda+6.5$	nm	
Side Mode Suppression Ratio	SMSR	30			dB	
Optical Extinction Ratio	ER	9			dB	
Generation Jitter 1(20KHZ-80MHZ)				0.3	UIp-p	1
Generation Jitter 2(4MHZ-80MHZ)				0.1	UIp-p	1
Dispersion penalty (@1450ps/nm, non-FEC rate)				2	dB	3
Dispersion penalty (@1300ps/nm, FEC rate)				3	dB	3
Optical Eye Mask 1			ITU-T G.691			1
Optical Eye Mask 2			IEEE802.3ae			2
Receiver						
Overload		-8			dBm	
Optical Center Wavelength	λ_C	1270		1600	nm	
LOS De-Assert	LOSD			-26	dBm	
LOS Assert	LOSA	-34			dBm	
LOS Hysteresis		0.5		5	dB	
Receiver Sensitivity @non-FEC rate	Pmin1			-23	dBm	3
Receiver Sensitivity @ FEC rate	Pmin2			-27	dBm	3

Notes:

1. Measured at 9.9532GBs, PRBS³¹-1, NRZ.
2. Measured at 10.3125Gbs, Non-framed PRBS^{2³¹}-1, NRZ.
3. Non-FEC rate refers 9.9/10.3/10.5 Gbs, and FEC rate refers 10.7/11.1/11.3 Gbs, BER of 1E-12 for non-FEC rate, and 1E-4 for FEC rate.

Pin Descriptions

Pin	Symbol	Name/Descriptions	Ref.
1	GND	Module Ground	
2	Vee5	(not required)	
3	MOD_DESEL	Module De-select; When Held low allows the module to respond to 2-wire serial interface. LVTTTL-I	
4	/INTERRUPT	Interrupt; Indicates presence of an important condition which can be read via the 2-wire serial interface. LVTTTL-O	2
5	TX_DIS	Transmitter Disable. Logic1 indicates laser output disabled, LVTTTL-I	
6	VCC5	+5V Power Supply (Not required)	
7	GND	Module Ground	1
8	VCC3	+3.3V Power Supply	
9	VCC3	+3.3V Power Supply	
10	SCL	2-Wire Serial Interface Clock. LVTTTL-I	2
11	SDA	2-Wire Serial Interface Data Line. LVTTTL-I/O	2
12	MOD_Abs	Indicates Module is not present. Grounded in the Module. LVTTTL-O	2
13	MOD_NR	Module Not Ready; Indicating Module Operational Fault. Open-collector. LVTTTL-O	2
14	RX_LOS	Loss of Signal indication. Logic 1 indicates loss of Signal. Open-collector. LVTTTL-O	2
15	GND	Module Ground	1
16	GND	Module Ground	1
17	RD-	Receiver Inverted Data Output. CML-O	
18	RD+	Receiver Non-Inverted Data Output. CML-O	
19	GND	Module Ground	1
20	VCC2	+1.8V Power Supply (Not required).	3
21	P_DOWN/RST	Power down; When high, requires the module to limit power consumption to 1.5W or below. 2-Wire serial interface must be functional in the low power mode. LVTTTL-I Reset; The falling edge initiates a complete reset of the module including the 2wire serial interface, equivalent to a power cycle. LVTTTL-I	
22	VCC2	+1.8V Power Supply (Not required)	3
23	GND	Module Ground	1
24	REFCLK+	Reference Clock (Not required)	
25	REFCLK-	Reference Clock (Not required)	
26	GND	Module Ground	1
27	GND	Module Ground	1
28	TD-	Transmitter Inverted Data Input. CML-I	
29	TD+	Transmitter Non-Inverted Data Input. CML-I	

30	GND	Module Ground	1
----	-----	---------------	---

Notes:

1. Module ground pins GND are isolated from the module case and chassis ground within the module.
2. Open collector; should be pulled up with 4.7K-10Kohms to a voltage between 3.15V and 3.6V on the host board.
3. The pins are open within module.

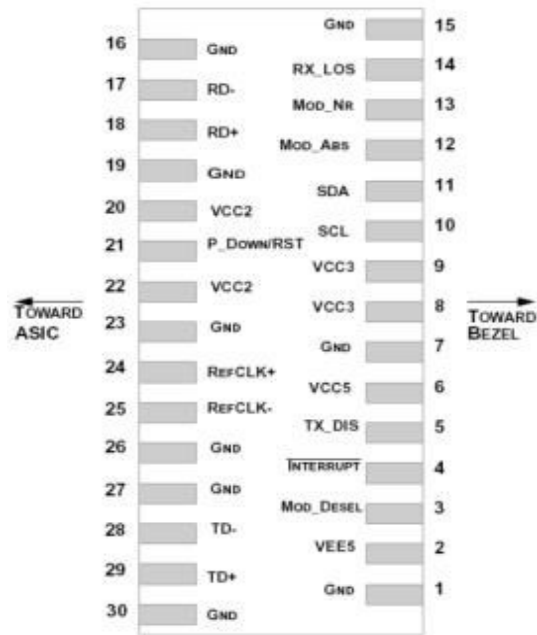

Pin-out of connector Block on Host board

Recommend Circuit Schematic

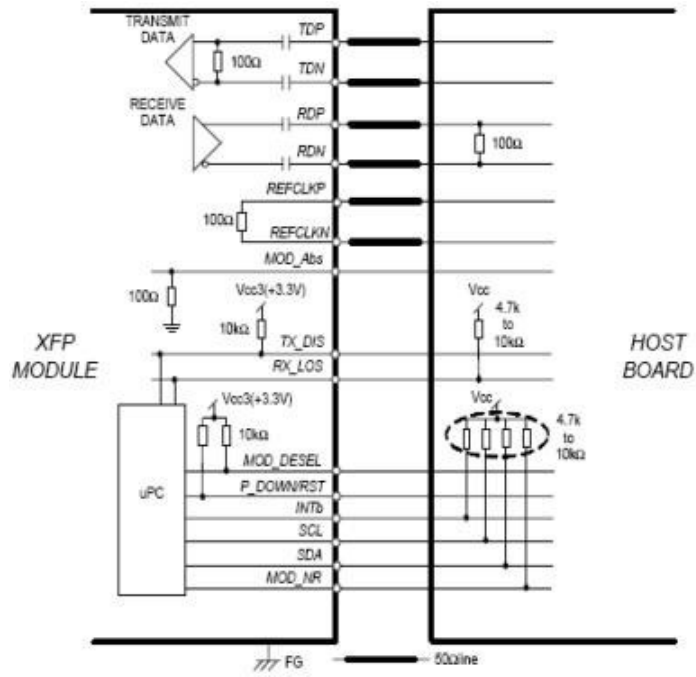

Mechanical Specifications

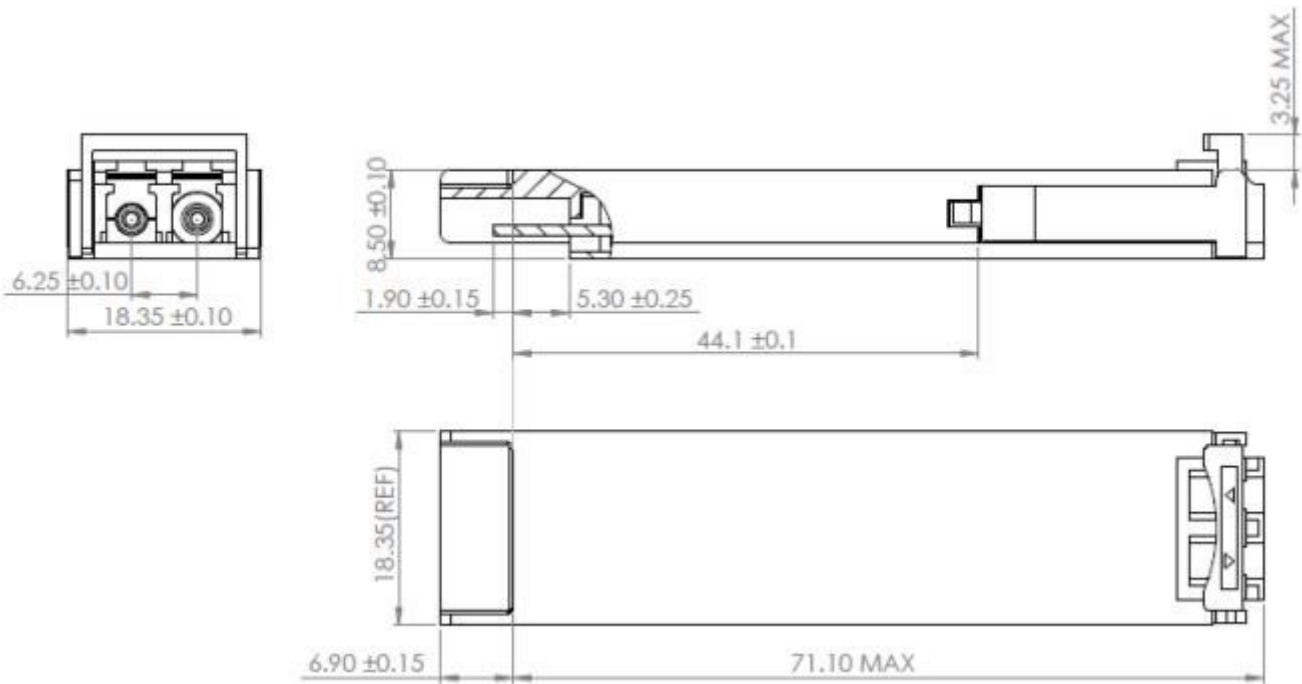

Management Interface

XFP 2-wire serial interface is specified in the Chapter 4 of the XFP MSA specification. The XFP 2-wire serial interface is used for serial ID, digital diagnostics, and certain control functions. The 2-wire serial interface is mandatory for all XFP modules. The 2-wire serial interface address of the XFP module is 1010000X(A0h). In order to access to multiple modules on the same 2-wire serial bus, the XFP has a MOD_DESEL(module deselect pin). This pin (which is pull high or deselected in the module) must be held low by the host to select of interest and allow communication over 2-wire serial interface. The module must not respond to or accept 2-wire serial bus instructions unless it is selected.

XFP Management Interface

XFP Management interface is specified in the Chapter 5 of the XFP MSA specification. The Figure 1 shows the structure of the memory map. The normal 256 Byte address space is divided into lower and upper blocks of 128 Bytes. The lower block of 128 Byte is always directly available and is used for the diagnostics and control functions that must be accessed repeatedly. Multiple blocks of memories are available in the upper 128 Bytes of the address space. These are individually addressed through a table select Byte which the user enters into a location in the lower address space. The upper address space tables are used for less frequently accessed functions and control space for future standards definition.

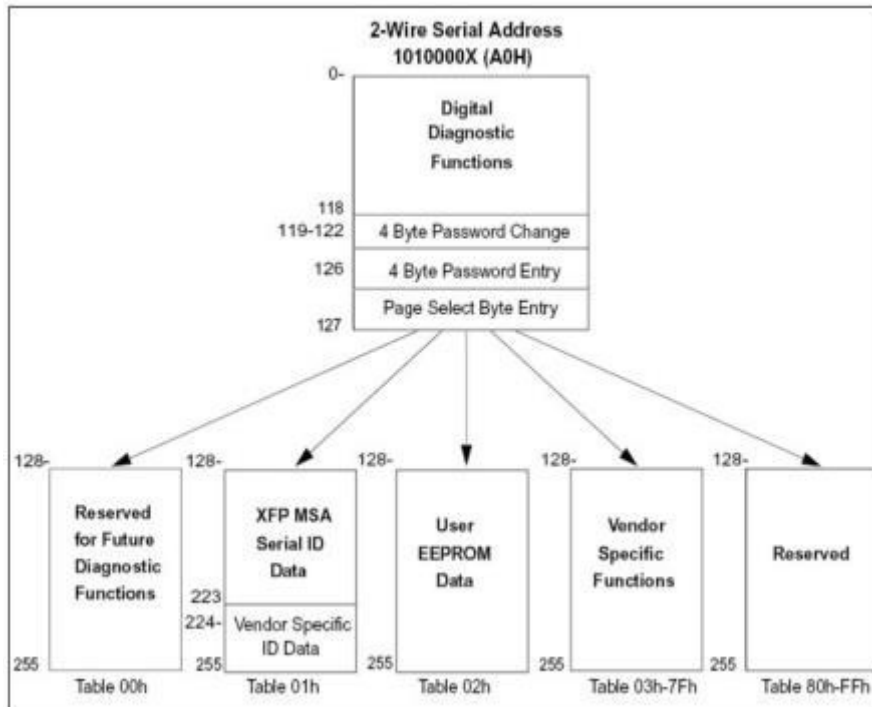

About Us:

Proline Options is one of North America's leading providers of transceivers and high speed cabling. With a reputation for quality, tested products that cover the connectivity spectrum, Proline Options has a solution for you regardless of the specification.

At Proline Options, every product is tested in its intended application - never batch or spec tested only. We run bandwidth, distance and IOS network tests. We have documented an impressive 0.03% failure rate over the last 10 years. To continue this rate of success we invest millions annually in our own on-site testing lab.



Tel: 855.933.3223

Email: sales@prolineoptions.com

Email: techsupport@prolineoptions.com

Web: <https://www.prolineoptions.com>