

### XFP-10G-25DWD40-PRO

Alcatel-Lucent Nokia® XFP-10G-25DWD40 Compatible TAA Compliant 10GBase-DWDM 100GHz XFP Transceiver (SMF, 1557.36nm, 40km, 0 to 70C, LC)

#### Features

- INF-8077i Compliance
- Temperature-stabilized EML transmitter and PIN receiver
- Duplex LC Connector
- Commercial Temperature 0 to 70 Celsius
- Single-mode Fiber
- Hot Pluggable
- Excellent ESD Protection
- Metal with Lower EMI
- RoHS Compliant and Lead Free



#### Applications:

- 10x Gigabit Ethernet over DWDM
- 8x/10x Fibre Channel
- Access, Metro and Enterprise

#### Product Description

This Alcatel-Lucent Nokia® XFP-10G-25DWD40 compatible XFP transceiver provides 10GBase-DWDM throughput up to 40km over single-mode fiber (SMF) using a wavelength of 1557.36nm via an LC connector. It is guaranteed to be 100% compatible with the equivalent Alcatel-Lucent Nokia® transceiver. This easy to install, hot swappable transceiver has been programmed, uniquely serialized and data-traffic and application tested to ensure that it will initialize and perform identically. Digital optical monitoring (DOM) support is also present to allow access to real-time operating parameters. This transceiver is Trade Agreements Act (TAA) compliant. We stand behind the quality of our products and proudly offer a limited lifetime warranty.

Proline's transceivers are RoHS compliant and lead-free.

TAA refers to the Trade Agreements Act (19 U.S.C. & 2501-2581), which is intended to foster fair and open international trade. TAA requires that the U.S. Government may acquire only "U.S. – made or designated country end products.



## Regulatory Compliance

- ESD to the Electrical PINs: compatible with MIL-STD-883E Method 3015.4
- ESD to the LC Receptacle: compatible with IEC 61000-4-3
- EMI/EMC compatible with FCC Part 15 Subpart B Rules, EN55022:2010
- Laser Eye Safety compatible with FDA 21CFR, EN60950-1& EN (IEC) 60825-1,2
- RoHS compliant with EU RoHS 2.0 directive 2015/863/EU

## Wavelength Guide (100GHz ITU-T Channel)

Channel #	Frequency (THz)	Center Wavelength (nm)
17	191.7	1563.86
18	191.8	1563.05
19	191.9	1562.23
20	192.0	1561.42
21	192.1	1560.61
22	192.2	1559.79
23	192.3	1558.98
24	192.4	1558.17
25	192.5	1557.36
26	192.6	1556.55
27	192.7	1555.75
28	192.8	1554.94
29	192.9	1554.13
30	193.0	1553.33
31	193.1	1552.52
32	193.2	1551.72
33	193.3	1550.92
34	193.4	1550.12
35	193.5	1549.32
36	193.6	1548.51
37	193.7	1547.72
38	193.8	1546.92
39	193.9	1546.12
40	194.0	1545.32
41	194.1	1544.53
42	194.2	1543.73
43	194.3	1542.94
44	194.4	1542.14

45	194.5	1541.35
46	194.6	1540.56
47	194.7	1539.77
48	194.8	1538.98
49	194.9	1538.19
50	195.0	1537.40
51	195.1	1536.61
52	195.2	1535.82
53	195.3	1535.04
54	195.4	1534.25
55	195.5	1533.47
56	195.6	1532.68
57	195.7	1531.90
58	195.8	1531.12
59	195.9	1530.33
60	196.0	1529.55
61	196.1	1528.77

### Absolute Maximum Ratings

Parameter	Symbol	Min.	Max.	Unit
Maximum Supply Voltage	Vcc3	-0.5	4.0	V
	Vcc5	-0.5	6.0	V
Storage Temperature	TS	-40	85	°C
Operating Case Temperature	TO	0	70	°C
Relative Humidity	RH	5	95	%
Data Rate		9.95	11.3	Gb/s

## Electrical Characteristics

Parameter	Symbol	Min.	Typ.	Max.	Unit	Notes
Power Supply Voltage	Vcc3	3.135	3.3	3.465	V	
	Vcc5	4.75	5.00	5.25	V	
Power Supply Current	Icc3			750	mA	
	Icc5			500		
Power Dissipation	Pd			3500	mW	
<b>Transmitter</b>						
Differential data input swing	Vin,pp	120		1000	mVp-p	
Input differential impedance	Zin		100		$\Omega$	
TX_Disable, P_Down/RST	VIH	2.0		Vcc3+0.3	V	
	VIL	-0.3		0.8	V	
Transmit Disable Assert Time				10	us	
<b>Receiver</b>						
Differential data output swing	Vout, pp	340		850	mVp-p	1
Output differential impedance	Zo		100		$\Omega$	
Data Output Rise Time, Fall Time	tr, tf	24			ps	2
Rx_LOS, Mod-NR, Interrupt	VOH	VccHost-0.5		VccHost+0.3	V	3
	VOL	0		0.4	V	3

### Notes:

1. Internally AC coupled, but requires an external 100 $\Omega$  differential termination.
2. 20-80%.
3. Loss of Signal is an open collector output. Should be pulled up with a 4.7k $\Omega$ -10k $\Omega$  resistor on the host board.

## Optical Characteristics

Parameter	Symbol	Min.	Typ.	Max.	Unit	Notes
<b>Transmitter</b>						
Launch Average Optical Power	Po	-1		+4	dBm	1
Center Wavelength Range	$\lambda_c$	1528.77		1563.86	nm	
Center Wavelength Spacing			100		GHz	
Center Wavelength Tolerance	$\Delta\lambda_c$	-100		100	pm	
Extinction Ratio	ER	9			dB	2
Spectral Width (-20dB)	$\Delta\lambda$			0.3	nm	
Side Mode Suppression Ratio	SMSR	30			dB	

<b>Average Optical Power (Laser Off)</b>	P <sub>off</sub>			-30	dBm	1
<b>Eye Diagram</b>	ITU-T G.691 SDH STM-64 L-64.2 compatible					2
<b>Receiver</b>						
<b>Center Wavelength</b>	$\lambda_c$	1528		1565	nm	
<b>Receiver Sensitivity @ 9.953Gb/s</b>	S			-24.0	dBm	3
<b>Receiver Sensitivity @ 11.1 Gb/s</b>	S			-15	dBm	4
<b>Receiver overload (P<sub>avg</sub>)</b>	POL	-1			dBm	3
<b>Path Penalty @1600ps @9.953Gb/s</b>	PP1			2	dB	3
<b>Path Penalty @1600ps @11.1 Gb/s</b>	PP2			3	dB	4
<b>Optical Return Loss</b>	ORL	27			dB	
<b>LOS De-Assert</b>	LOSD			-27	dBm	
<b>LOS Assert</b>	LOSA	-38			dBm	
<b>LOS Hysteresis</b>		0.5			dB	

**Notes:**

1. Measured with worst ER; 1550nm; PRBS 2<sup>31</sup>-1 test pattern @ 9.953 Gb/s, BER<10<sup>-12</sup>.
2. Measured with worst ER; 1550nm; PRBS 2<sup>31</sup>-1 test pattern @ 11.1 Gb/s, BER<10<sup>-12</sup>.

## Pin Descriptions

Pin	Logic	Symbol	Name/Descriptions	Ref.
1		GND	Module Ground	1
2		Vee5	Optional -5.2v Power Supply (not required)	
3	LVTTTL-I	MOD_DESEL	Module De-select; When Held low allows the module to respond to 2-wire serial interface.	
4	LVTTTL-O	INTERRUPT	Interrupt; Indicates presence of an important condition which can be read via the 2-wire serial interface.	2
5	LVTTTL-I	TX_DIS	Transmitter Disable; Turns off transmitter laser output	
6		VCC5	+5V Power Supply	
7		GND	Module Ground	1
8		VCC3	+3.3V Power Supply	
9		VCC3	+3.3V Power Supply	
10	LVTTTL-I/O	SCL	2-Wire Serial Interface Clock.	2
11	LVTTTL-I/O	SDA	2-Wire Serial Interface Data Line.	2
12	LVTTTL-O	MOD_Abs	Indicates Module is not present. Grounded in the Module.	2
13	LVTTTL-O	MOD_NR	Module Not Ready; Indicating Module Operational Fault.	2
14	LVTTTL-O	RX_LOS	Receiver Loss of Signal Indicator	2
15		GND	Module Ground	1
16		GND	Module Ground	1
17	CML-O	RD-	Receiver Inverted Data Output	
18	CML-O	RD+	Receiver Non-Inverted Data Output.	
19		GND	Module Ground	1
20		VCC2	+1.8V Power Supply (Not required).	
21	LVTTTL-I	P_DOWN/RST	Power down; When high, requires the module to limit power consumption to 1.5W or below. 2-Wire serial interface must be functional in the low power mode. Reset; The falling edge initiates a complete reset of the module including the 2-wire serial interface, equivalent to a power cycle.	
22		VCC2	+1.8V Power Supply (Not required)	
23		GND	Module Ground	1
24	PECL-I	REFCLK+	Reference Clock Non-Inverted Input, AC coupled on the host board- not required.	3
25		REFCLK-	Reference Clock Inverted Input, AC coupled on the host board-Not Required	3
26		GND	Module Ground	1
27		GND	Module Ground	1
28	CML-I	TD-	Transmitter Inverted Data Input.	
29	CML-I	TD+	Transmitter Non-Inverted Data Input.	
30		GND	Module Ground	1

**Notes:**

1. Module ground pins GND are isolated from the module case.
2. Shall be pulled up with 4.7KΩ to 10KΩ to a voltage between 3.15V and 3.45V on the host board.
3. Reference Clock is not required. If present, it will be ignored.



Pin-out of connector Block on Host board

### OSNR Characteristics

Bit Rate (Gbps)	Dispersion (ps/nm)	OSNR (dB)	Receiver Sensitivity (dBm)	BER
9.95/10.3	0	>30	-24 ~-7	10E-12
		>25	-18 ~-7	
	1200	>30	-23 ~-7	
		>27	-18 ~-7	
	1600	>30	-22 ~-7	
		>28	-18 ~-7	
10.7/11.1 with FEC	0	>30	-26 ~-7	10E-4
		>16	-18 ~-7	
	1200	>30	-25 ~-7	
		>18	-18 ~-7	
	1600	>30	-22 ~-7	
		>20	-18 ~-7	

### Recommended Application Interface Block Diagram

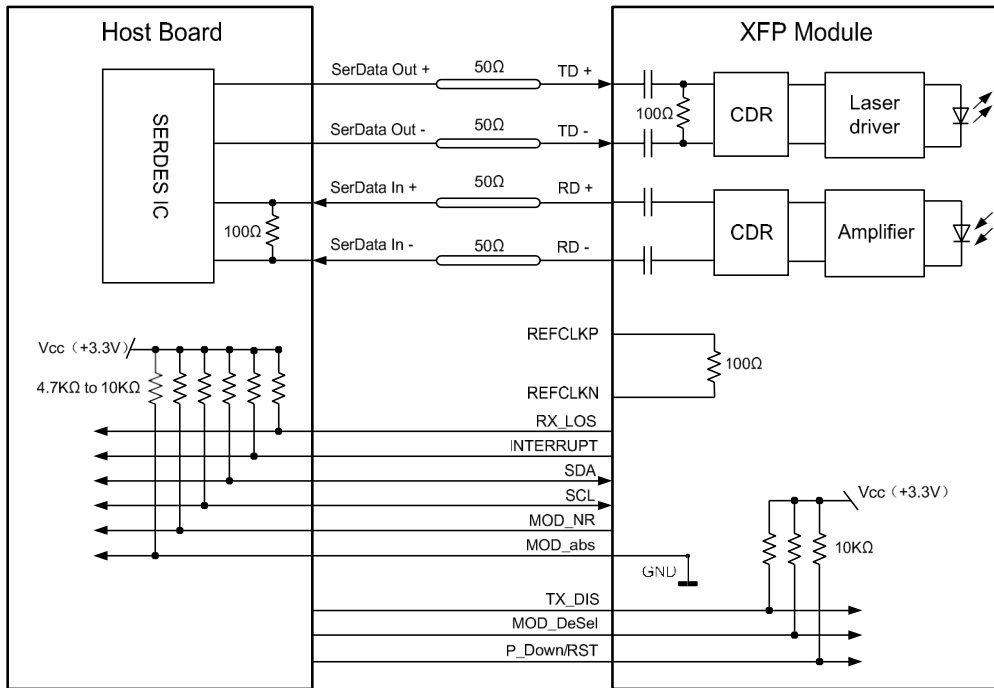



### Recommended Host Board Power Supply Filter Network

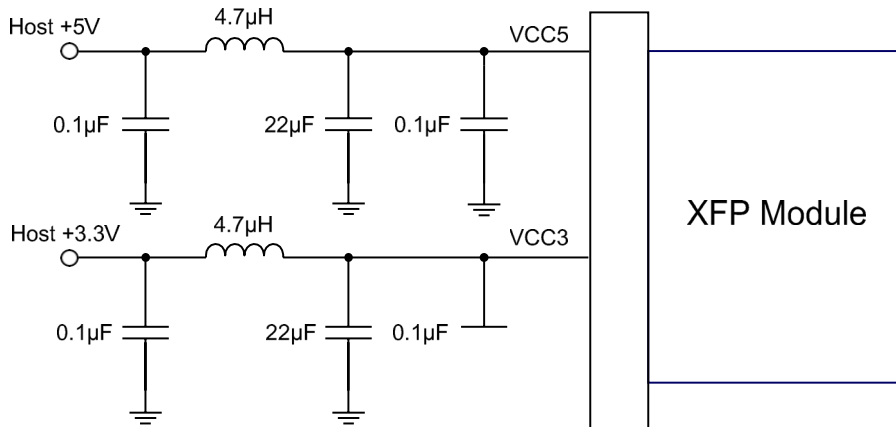

### Management Interface

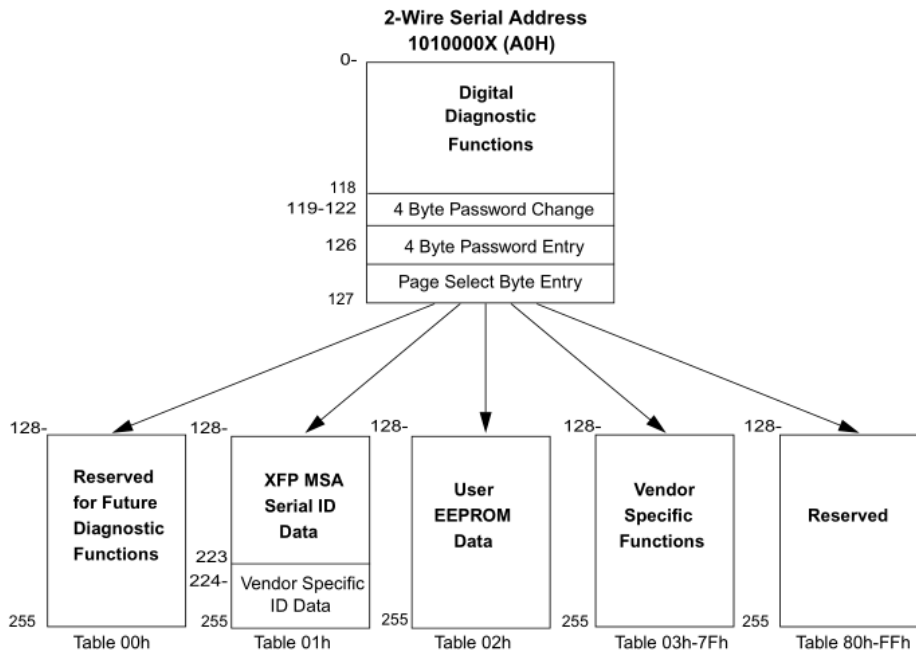

### Mechanical Specifications

Small Form Factor Pluggable (XFP) transceivers are compatible with the dimensions defined by the XFP Multi-Sourcing Agreement (MSA).

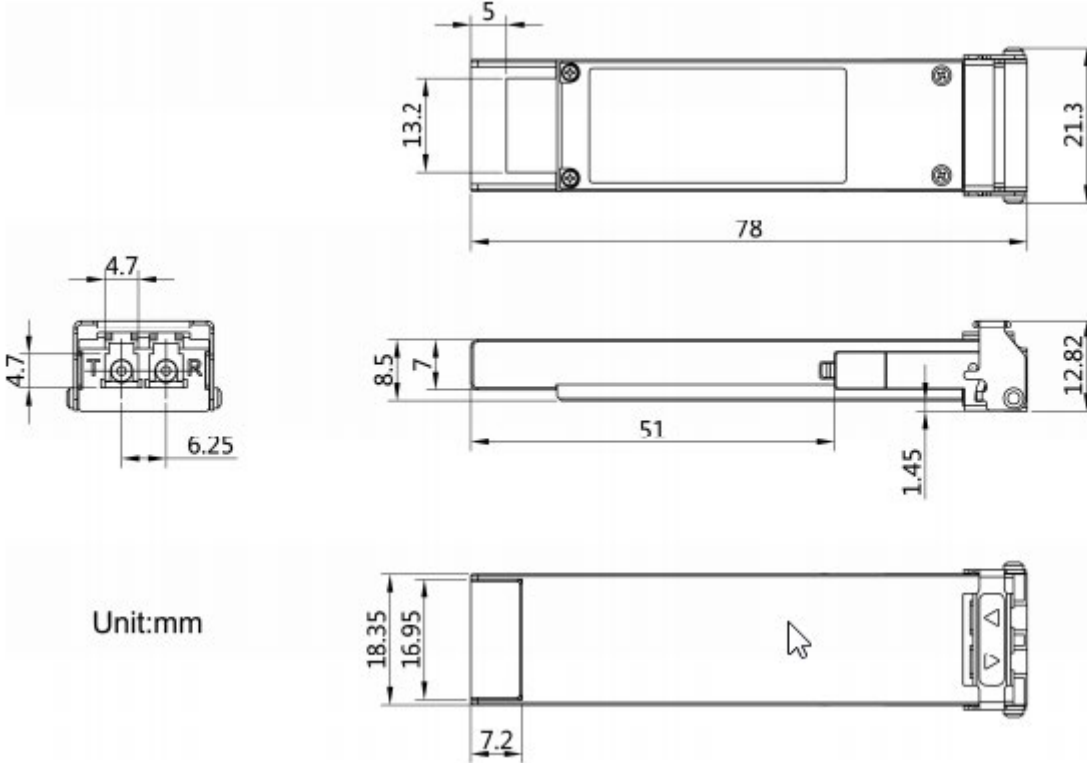

**About Us:**

Proline Options is one of North America's leading providers of transceivers and high speed cabling. With a reputation for quality, tested products that cover the connectivity spectrum, Proline Options has a solution for you regardless of the specification.

At Proline Options, every product is tested in its intended application - never batch or spec tested only. We run bandwidth, distance and IOS network tests. We have documented an impressive 0.03% failure rate over the last 10 years. To continue this rate of success we invest millions annually in our own on-site testing lab.



Tel: 855.933.3223

Email: [sales@prolineoptions.com](mailto:sales@prolineoptions.com)

Email: [techsupport@prolineoptions.com](mailto:techsupport@prolineoptions.com)

Web: <https://www.prolineoptions.com>