

### SFP-10GB-PDAC1-5M-I-J-PRO

Juniper Networks® Compatible TAA 10GBase-CU SFP+ to SFP+ Direct Attach Cable (Passive Twinax, 1.5m, -40 to 85C)

#### Features

- Compliant to SFF-8431/8432 and INF-8074
- Up to 10.3125Gbps
- 1.5m length
- Passive copper
- Built-in EEPROM function
- 30AWG Wire Gauge
- Single 3.3V power supply
- Industrial Temperature: -40C to 85C
- Metal with lower EMI
- RoHS Compliant and Lead-Free



#### Applications

- 10G Ethernet
- 10G Fiber Channel
- Datacenters and Mobile Networks

#### Product Description

This is a Juniper Networks® compatible 10GBase-CU SFP+ to SFP+ direct attach cable that operates over passive copper with a maximum reach of 1.5m. It has been programmed, uniquely serialized, and data-traffic and application tested to ensure it is 100% compliant and functional. This direct attach cable is TAA (Trade Agreements Act) compliant, and is built to comply with MSA (Multi-Source Agreement) standards. We stand behind the quality of our products and proudly offer a limited lifetime warranty.

Proline Options' direct attach cables are RoHS compliant and lead free.

TAA refers to the Trade Agreements Act (19 U.S.C. & 2501-2581), which is intended to foster fair and open international trade. TAA requires that the U.S. Government may acquire only "U.S. – made or designated country end products."



## Regulatory Compliance

- ESD to the Electrical PINs: compatible with MIL-STD-883 Method 3015.
- ESD to the Duplex LC Receptacle: compatible with IEC 61000-4-2.
- Immunity: compatible with IEC 61000-4-3.
- EMI: compatible with FCC Part 15 Class B EN55022 Class B (CISPR 22B) VCCI Class B.
- Laser Eye Safety: compatible with FDA 21CFR 1040.10 and 1040.11 EN60950, EN (IEC) 60825-1, 2.
- RoHS: compliant with 2002/95/EC 4.1&4.2 2005/747/EC.

## General Specifications

Parameter	Symbol	Min.	Typ.	Max.	Unit
Supply Voltage	Vcc	3.13	3.3	3.47	V
Storage Temperature	Tstg	-40		85	°C
Operating Case Temperature	Tc	-40		85	°C
Humidity	RH	5		85	%
Data Rate			10		Gbps

## Cable Specifications

Parameter	Symbol	Min.	Typ.	Max.	Unit
Length	L			1.5	M
AWG		30			AWG
Jacket Material	PVC, Black (Or Customization)				

## Electrical Specifications

Parameter	Symbol	Min.	Typ.	Max.	Unit
Resistance	Rcon			3	Ω
Insulation Resistance	Rins			10	MΩ
Raw Cable Impedance	Zca	95	100	110	Ω
Mated Connector Impedance	Zmated	85	100	110	Ω
Insertion Loss at 5.16GHz	SDD21			17.04	dB
Return Loss	SDD11/22	$\text{Return\_loss}(f) \geq \begin{cases} 12-2\sqrt{f} & 0.05 \leq f < 4.1 \\ 6.3-13\log_{10}(f/5.5) & 4.1 \leq f \leq 10 \end{cases}$			dB

## Pin Descriptions

Pin	Logic	Symbol	Power Sequence Order	Name/Description	Note
1		VeeT	1 <sup>st</sup>	Module Transmitter Ground.	3
2	LVTTL-O	Tx_Fault	3 <sup>rd</sup>	Module Transmitter Fault.	4
3	LVTTL-I	Tx_Disable	3 <sup>rd</sup>	Transmitter Disable. Turns off the transmitter laser output.	5
4	LVTTL-I/O	SDA	3 <sup>rd</sup>	2-Wire Serial Interface Data (Same as MOD_DEF2 in INF-8074i).	
5	LVTTL-I/O	SCL	3 <sup>rd</sup>	2-Wire Serial Interface Clock (Same as MOD_DEF1 in INF-8074i).	
6		MOD_ABS	3 <sup>rd</sup>	Module Absent. Connected to VeeT or VeeR in the module.	
7	LVTTL-I	RS0	3 <sup>rd</sup>	Rate Select 0. Optionally controls the SFP+ module receiver.	
8	LVTTL-O	Rx_LOS	3 <sup>rd</sup>	Receiver Loss of Signal Indication. In FC, designated as Rx_LOS. In Ethernet, designated as Signal Detect.	4
9	LVTTL-I	RS1	3 <sup>rd</sup>	Rate Select 1. Optionally controls the SFP+ module transmitter.	
10		VeeR	1 <sup>st</sup>	Module Receiver Ground.	3
11		VeeR	1 <sup>st</sup>	Module Receiver Ground.	3
12	CML-O	RD-	3 <sup>rd</sup>	Receiver Inverted Data Output.	
13	CML-O	RD+	3 <sup>rd</sup>	Receiver Non-Inverted Data Output.	
14		VeeR	1 <sup>st</sup>	Module Receiver Ground.	3
15		VccR	2 <sup>nd</sup>	+3.3V Module Receiver Supply.	
16		VccT	2 <sup>nd</sup>	+3.3V Module Transmitter Supply.	
17		VeeT	1 <sup>st</sup>	Module Transmitter Ground.	3
18	CML-I	TD+	3 <sup>rd</sup>	Transmitter Non-Inverted Data Input.	
19	CML-I	TD-	3 <sup>rd</sup>	Transmitter Inverted Data Input.	
20		VeeT	1 <sup>st</sup>	Module Transmitter Ground.	3

### Notes:

1. Labeling as inputs (I) and outputs (O) are from the perspective of the module.
2. The case makes electrical contact with the cage before any of the board edge contacts are made.
3. The module signal ground contacts, VeeR and VeeT, should be isolated from the module case.
4. This contact is an open collector/drain output contact and shall be pulled up on the host board. Pull-ups can be connected to one of several power supplies; however, the host board design shall ensure that no module contact has a voltage exceeding the module VccT/R+0.5V.
5. Tx\_Disable is an input contact with a 4.7kΩ to 10kΩ pull-up to the VccT inside the module.

### Electrical Pin-Out Details for SFP

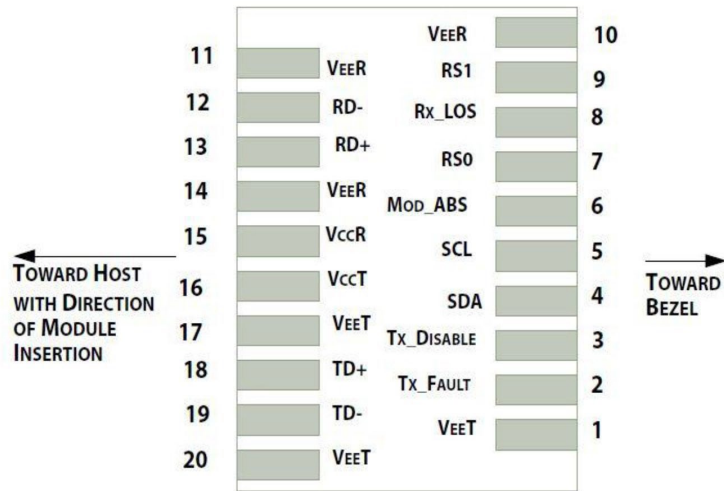

### Mechanical Specifications

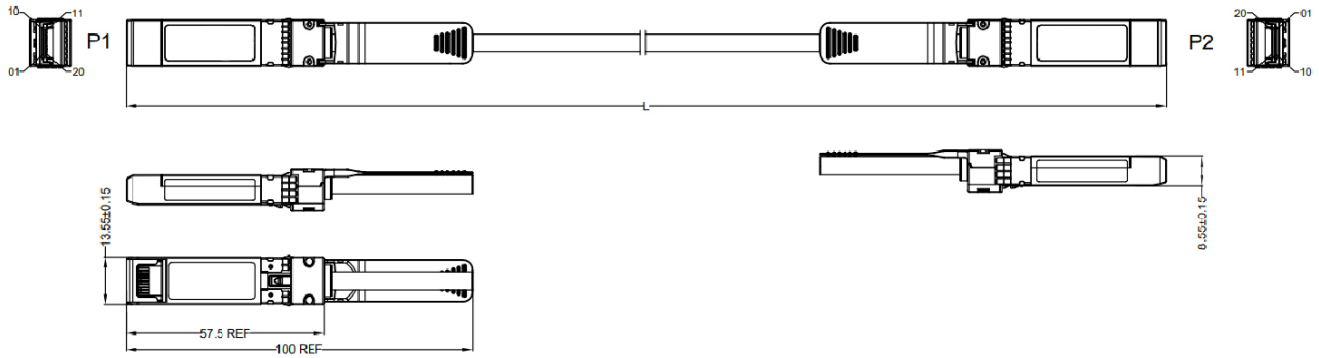

### Cable Cross Section

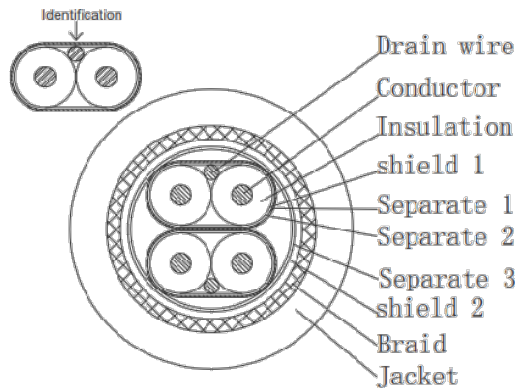

**About Us:**

Proline Options is one of North America's leading providers of transceivers and high-speed cabling. With a reputation for quality, tested products that cover the connectivity spectrum, Proline Options has a solution for you regardless of the specification.

At Proline Options, every product is tested in its intended application - never batch or spec tested only. We run bandwidth, distance and IOS network tests. We have documented an impressive 0.03% failure rate over the last 10 years. To continue this rate of success we invest millions annually in our own on-site testing lab.

Tel: 855.933.3223

Email: [sales@prolineoptions.com](mailto:sales@prolineoptions.com)

Email: [techsupport@prolineoptions.com](mailto:techsupport@prolineoptions.com)

Web: <https://www.prolineoptions.com>