

SFP-10GB-DW64-80-I-PRO

MSA and TAA Compliant 10GBase-DWDM 50GHz SFP+ Transceiver (SMF, 1526.44nm, 80km, DOM, -40 to 85C, LC)

Features

- SFF-8432 and SFF-8472 Compliance
- Single-mode Fiber
- Duplex LC Connector
- Hot Pluggable
- Metal with Lower EMI
- Industrial Temperature -40 to 85 Celsius
- RoHS Compliant and Lead Free
- Excellent ESD Protection



Applications:

- 10x Gigabit Ethernet over DWDM
- 8x/10x Fibre Channel
- Access and Enterprise

Product Description

This MSA Compliant SFP+ transceiver provides 10GBase-DWDM throughput up to 80km over single-mode fiber (SMF) using a wavelength of 1526.44nm via an LC connector. It is built to MSA standards and is uniquely serialized and data-traffic and application tested to ensure that they will integrate into your network seamlessly. Digital optical monitoring (DOM) support is also present to allow access to real-time operating parameters. This transceiver is Trade Agreements Act (TAA) compliant. We stand behind the quality of our products and proudly offer a limited lifetime warranty.

Proline's transceivers are RoHS compliant and lead-free.

TAA refers to the Trade Agreements Act (19 U.S.C. & 2501-2581), which is intended to foster fair and open international trade. TAA requires that the U.S. Government may acquire only "U.S. – made or designated country end products.



Regulatory Compliance

- ESD to the Electrical PINs: compatible with MIL-STD-883E Method 3015.4.
- ESD to the LC Receptacle: compatible with IEC 61000-4-3.
- EMI/EMC: compatible with FCC Part 15 Subpart B Rules, EN55022:2010.
- Laser Eye Safety: compatible with FDA 21CFR, EN60950-1& EN (IEC) 60825-1, 2.
- RoHS: compliant with EU RoHS 2.0 directive 2015/863/EU.

Wavelength Guide (100GHz ITU-T Channel)

ITU Channel #	Frequency (THZ)	Center Wavelength (nm)
64	196.4	1526.44
63	196.3	1527.22
62	196.2	1527.99
61	196.1	1528.77

Absolute Maximum Ratings

Parameter	Symbol	Min.	Typ.	Max.	Unit	Notes
Maximum Supply Voltage	Vcc	-0.5		3.6	V	
Storage Temperature	Tstg	-40		85	°C	
Operating Case Temperature	Tc	-40		85	°C	
Operating Humidity	RH	0		95	%	
Bit Rate	BR			11.1	Gbps	1
Bit Error Ratio	BER			10e ⁻¹²		2
Max. Supported Link Length	LMAX			80	km	1

Notes:

1. 10GBase-ZR, 10GBase-ZW, and 1200-SM-LL-L 10GFC.
2. Tested with a 2³¹-1 PRBS.

Electrical Characteristics

Parameter	Symbol	Min.	Typ.	Max.	Unit	Notes
Power Supply Voltage	Vcc	3.14	3.3	3.46	V	
Module Power	Icc			2000	mW	
Transmitter						
Input Differential Impedance	ZIN	80	100	120	Ω	
Differential Data Input	VIN	180		700	mVp-p	
Tx_Fault	Assert	VFA	2.0		Host_Vcc	V
	De-Assert	VFDA	Vee		Vee+0.4	V
Tx_Disable	Transmitter Disable	VIH	2.0		Host_Vcc	V
	Transmitter Enable	VIL	Vee		Vee+0.8	V
Receiver						
Differential Data Output	VOUT	350		850	mVp-p	
Output Rise Time	Tr	25			pS	
Output Fall Time	Tf	25			pS	
LOS Fault	LOS	2.0			Host_Vcc	V
LOS Normal	LOS	Vee			Vee+0.4	V

Optical Characteristics

Parameter	Symbol	Min.	Typ.	Max.	Unit	Notes
Transmitter						
Average Launch Optical Power	POUT	0		4	dBm	1
Center Wavelength Range	λ_C	1526.44		1563.86	nm	
Center Wavelength Spacing			100		GHz	
Center Wavelength Tolerance	$\Delta\lambda_C$	x-100	x	x-100	pm	
Extinction Ratio	ER	8.2			dB	
Side-Mode Suppression Ratio	SMSR	30			dB	
Relative Intensity Noise	RIN			-128	dB/Hz	
Average Launch Power of Off Tx	Poff			-30	dBm	
Receiver						
Optical Center Wavelength	λ_C	1260		1620	nm	
Receiver Sensitivity	RSENSE			-24	dBm	2
Receiver Sensitivity @80km Fiber	RSENSE			-21	dBm	3
Receiver Overload	P _{OL}	-7			dBm	
Optical Return Loss	ORL	27			dB	
LOS De-Assert	LOSD			-27	dBm	
LOS Assert	LOSA	-37			dBm	
LOS Hysteresis		0.5			dB	

Notes:

1. The optical power is launched into the SMF.
2. Measured at 1528-1600nm, ER>9dBm, PRBS 2³¹-1, and BER better than or equal to 10E⁻¹².
3. Loopback using 80km fiber (SMF-28).

Pin Descriptions

Pin	Symbol	Name/Description	Note
1	VeeT	Transmitter Ground (Common with Receiver Ground).	1
2	Tx_Fault	Transmitter Fault. LVTTTL-O.	2
3	Tx_Disable	Transmitter Disable. Laser output disabled on “high” or “open.” LVTTTL-I.	3
4	SDA	2-Wire Serial Interface Data (Same as MOD-DEF2 in INF-8074i). LVTTTL-I/O.	
5	SCL	2-Wire Serial Interface Clock (Same as MOD-DEF2 in INF-8074i). LVTTTL-I.	
6	MOD_ABS	Module Absent. Connect to the VeeT or VeeR in the module.	4
7	RS0	Rate Select 0. Not Used.	5
8	LOS	Loss of Signal Indication. “Logic 0” indicates normal operation. LVTTTL-O.	2
9	RS1	Rate Select 1. Not Used.	5
10	VeeR	Receiver Ground (Common with Transmitter Ground).	1
11	VeeR	Receiver Ground (Common with Transmitter Ground).	1
12	RD-	Receiver Inverted Data Out. AC Coupled. CML-O.	
13	RD+	Receiver Non-inverted Data Out. AC Coupled. CML-O.	
14	VeeR	Receiver Ground (Common with Transmitter Ground).	1
15	VccR	Receiver Power Supply.	
16	VccT	Transmitter Power Supply.	
17	VeeT	Transmitter Ground (Common with Receiver Ground).	1
18	TD+	Transmitter Non-Inverted Data In. AC Coupled. CML-I.	
19	TD-	Transmitter Inverted Data In. AC Coupled. CML-O.	
20	VeeT	Transmitter Ground (Common with Receiver Ground).	1

Notes:

1. The module signal ground contacts, VeeR and VeeT, should be isolated from the module case.
2. This contact is an open collector/drain output and should be pulled up to the Vcc_Host with resistor in the range 4.7kΩ-10kΩ. Pull-ups can be connected to one or several power supplies; however, the host board design shall ensure that no module contract has voltage exceeding module VccT/R+0.5V.
3. Tx_Disable is an input contact with a 4.7kΩ-10kΩ pull-up resistor to the VccT inside the module.
4. MOD_ABS is connected to the VeeT or VeeR in the SFP+ module. The host may pull the contract up to Host_Vcc with a resistor in the range from 4.7kΩ-10kΩ. MOD_ABS is asserted “high” when the SFP+ module is physically absent from a host slot.
5. Internally pulled down per SFF-8431.

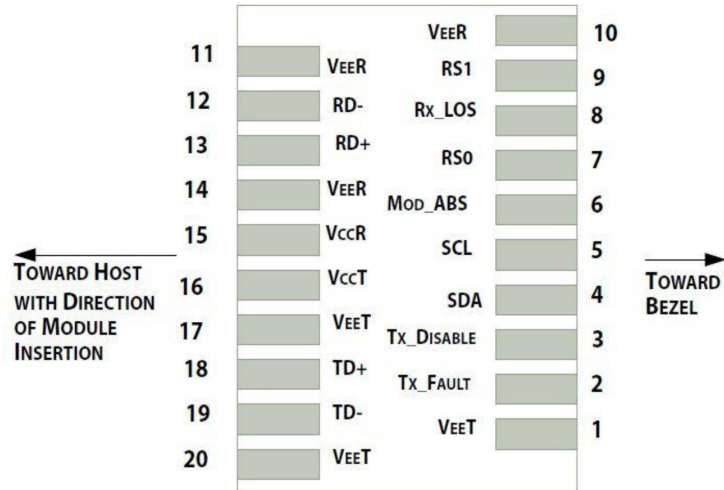

Pin-Out of Connector Block on the Host Board

Recommended Circuit Schematic



Mechanical Specifications

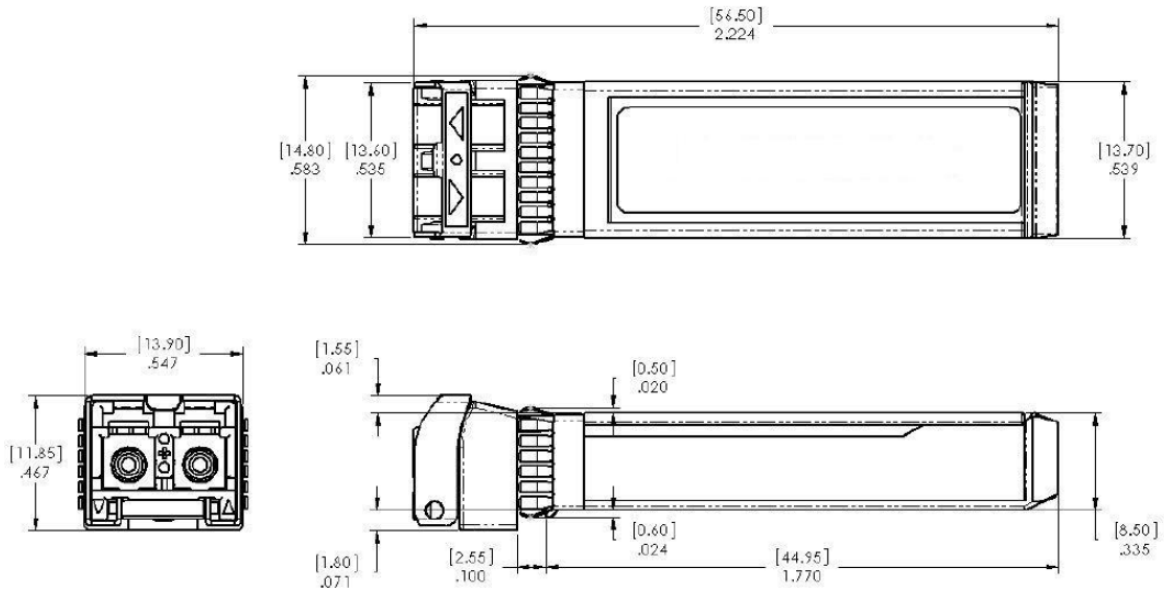

EEPROM Information

EEPROM memory map-specific data field description is as below:

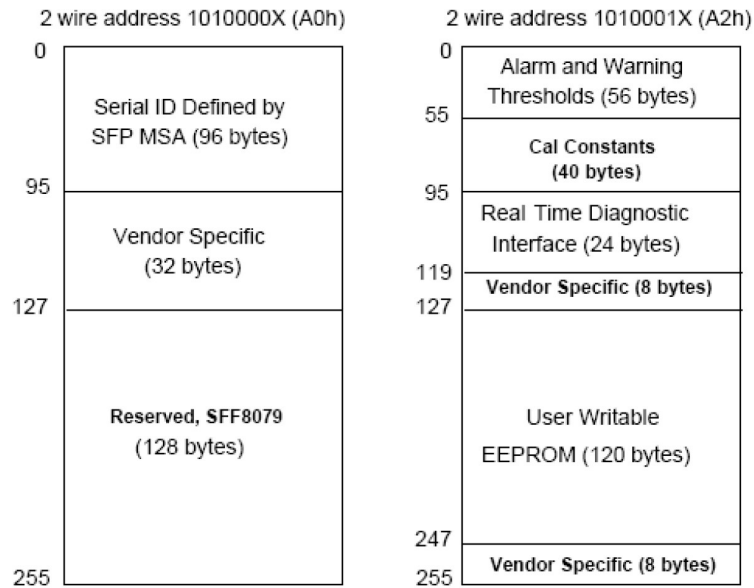

About Us:

Proline Options is one of North America's leading providers of transceivers and high speed cabling. With a reputation for quality, tested products that cover the connectivity spectrum, Proline Options has a solution for you regardless of the specification.

At Proline Options, every product is tested in its intended application - never batch or spec tested only. We run bandwidth, distance and IOS network tests. We have documented an impressive 0.03% failure rate over the last 10 years. To continue this rate of success we invest millions annually in our own on-site testing lab.



Tel: 855.933.3223

Email: sales@prolineoptions.com

Email: techsupport@prolineoptions.com

Web: <https://www.prolineoptions.com>