

QSFP-4SFP-AOC2M-PRO

MSA and TAA 40GBase-AOC QSFP+ to 4xSFP+ Active Optical Cable (850nm, MMF, 2m)

Features

- 850nm VCSEL transmitter, PIN photo-detector receiver
- Electrical interface compliant to QSFP+ connector (SFF-8436) and SFP+ connectors (SFF-8431)
- All-metal housing for superior EMI performance
- Operating temperature: 0 to 70 Celsius
- RoHS compliant and Lead free
- Hot Pluggable



Applications:

- 40GBase Ethernet
- Fiber Channel Application
- InfiniBand QDR, SDR, DDR
- Servers, switches, storage, and host card adapters

Product Description

This is a MSA Compliant 40GBase-AOC QSFP+ to 4xSFP+ active optical cable that operates over active fiber with a maximum reach of 2m. It has been programmed, uniquely serialized, and data-traffic and application tested to ensure it is 100% compliant and functional. We stand behind the quality of our products and proudly offer a limited lifetime warranty. This cable is TAA (Trade Agreements Act) compliant and is built to comply with MSA (Multi-Source Agreement) standards.

Proline's transceivers are RoHS compliant and lead-free.

TAA refers to the Trade Agreements Act (19 U.S.C. & 2501-2581), which is intended to foster fair and open international trade. TAA requires that the U.S. Government may acquire only "U.S. – made or designated country end products.



QSFP Interface Specifications

Parameter	Description
Module Form Factor	QSFP+ (Supports SFF-8436/SFF-8472)
Channel Data Rate	Rate 40Gbps
BER	$<10^{-12}$
Operating Case Temperature	0 °C to 70°C
Storage Temperature	-20 °C to 85°C
Supply Voltage	3.3V
Supply Current	180mA Per End Typical
Management Interface Serial	I ² C (Supports SFF-8472)

Optical Characteristics

Parameter	Symbol	Min.	Typ.	Max.	Unit	Notes
Transmitter						
Center Wavelength	λ_C	840	850	860	nm	
RMS Spectral Width	$\Delta\lambda$			0.65	nm	
Average Launch Power Per Lane	POUT	-7.5		-2.5	dBm	
Difference in Launch Power Between Any Two Lanes (OMA)					dB	
Extinction Ratio	ER	3			dB	
Peak Power Per Lane				4	dBm	
Transmitter and Dispersion Penalty (TDP) Per Lane	TDP			3.5	dB	
Average Launch Power of Off Transmitter Per Lane				-30	dB	
Eye Mask Coordinates: (X1, X2, X3, Y1, Y2, Y3)		(0.23, 0.34, 0.43, 0.27, 0.33, 0.4)				Hit Ratio = 5×10^{-5}
Receiver						
Center Wavelength	λ_C	840	850	860	nm	
Stressed Receiver Sensitivity in OMA Per Lane				-5.4		1
Maximum Average Power at Receiver Input Per Lane				2.4		
Receiver Reflectance				-12		
Peak Power Per Lane				4		
LOS Assert		-30				
LOS De-Assert – OMA				7.5		
LOS Hysteresis		0.5				

Notes:

1. Measured with conformance test signal at TP3 for BER= $10E^{-12}$.

SFP+ Interface Specifications

Parameter	Description
Module Form Factor	SFP+ (Supports SFF8431/SFF8432/SFF8472)
Channel Data Rate	Rate 1 to 10.3125Gbps
BER	$<10^{-12}$
Operating Case Temperature	0 to 70°C
Storage Temperature	-20 to 85°C
Supply Voltage	3.3V
Supply Current	455mA Maximum
Management Interface Serial	I ² C (Supports SFF-8472)

Optical Characteristics

Parameter	Symbol	Min.	Typ.	Max.	Unit	Notes
Transmitter						
Center Wavelength	λ_C	840	850	860	nm	
RMS Spectral Width	$\Delta\lambda$			Note 1	nm	
Average Optical Power	P_{avg}	-6.5		-1	dBm	2
Extinction Ratio	ER	3.5			dB	3
Transmitter Dispersion Penalty	TDP			3.9	dB	
Relative Intensity Noise	RIN			-128	dB/Hz	-12B Reflection
Optical Return Loss Tolerance				12	dB	
Receiver						
Center Wavelength	λ_C	840	850	860	nm	
Receiver Sensitivity	P_{sens}			-11.1	dBm	4
Stressed Sensitivity in OMA				-7.5	dBm	4
LOS Function	LOS	-30		-12	dBm	
Overload	P_{in}			-1.0	dBm	4
Receiver Reflectance				-12	dB	

Notes:

1. Trade-offs are available between spectral width, center wavelength, and minimum OMA.
2. The optical power is launched into MMF.
3. Measured with a PRBS $2^{31}-1$ test pattern @10.3125Gbps.
4. Measured with a PRBS $2^{31}-1$ test pattern @10.3125Gbps and $BER \leq 10^{-12}$.

Mechanical Specifications

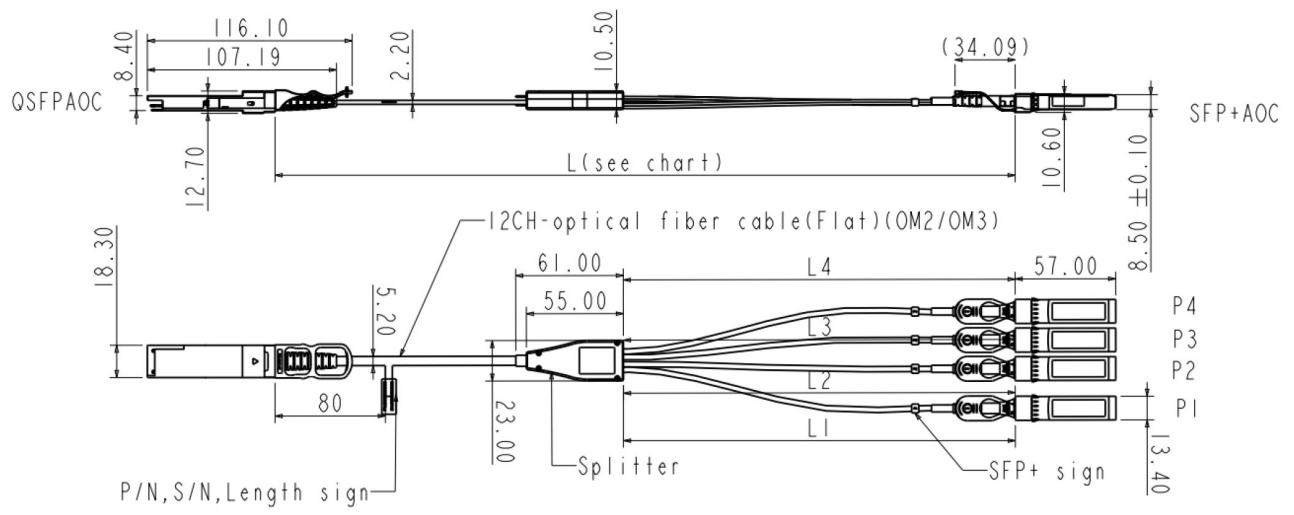

About Us:

Proline Options is one of North America's leading providers of transceivers and high speed cabling. With a reputation for quality, tested products that cover the connectivity spectrum, Proline Options has a solution for you regardless of the specification.

At Proline Options, every product is tested in its intended application - never batch or spec tested only. We run bandwidth, distance and IOS network tests. We have documented an impressive 0.03% failure rate over the last 10 years. To continue this rate of success we invest millions annually in our own on-site testing lab.



Tel: 855.933.3223

Email: sales@prolineoptions.com

Email: techsupport@prolineoptions.com

Web: <https://www.prolineoptions.com>