

QSFP-100GB-130231-20-E-PRO

MSA and TAA Compliant 100GBase-OWDM 400GHz QSFP28 Transceiver (SMF, 1302.31nm, 20km, DOM, -5 to 80C, LC)

Features

- Hot-pluggable QSFP28 form factor
- Supports 106.25Gb/s (PAM4)
- Compliant with QSFP28 MSA
- High Sensitivity APD Receiver
- OWDM 8 Wavelengths
- Duplex LC receptacles
- Aligned with IEEE 802.3bs and 100G Lambda MSA
- Single +3.3V power supply
- Operating temperature: -5 to +80 Celsius
- I2C management interface
- RoHS Compliant and Lead-Free



Applications:

- 100GBase Ethernet
- Access and Enterprise

Product Description

This MSA Compliant QSFP28 transceiver provides 100GBase-OWDM throughput up to 20km over single-mode fiber (SMF) using a wavelength of 1302.31nm via an LC connector. It is built to MSA standards and is uniquely serialized and data-traffic and application tested to ensure that they will integrate into your network seamlessly. Digital optical monitoring (DOM) support is also present to allow access to real-time operating parameters. This transceiver is Trade Agreements Act (TAA) compliant. We stand behind the quality of our products and proudly offer a limited lifetime warranty.

Proline's transceivers are RoHS compliant and lead-free.

TAA refers to the Trade Agreements Act (19 U.S.C. & 2501-2581), which is intended to foster fair and open international trade. TAA requires that the U.S. Government may acquire only "U.S. – made or designated country end products.



Absolute Maximum Ratings

Parameter	Symbol	Min.	Max.	Unit
Maximum Supply Voltage	Vcc	0	3.6	V
Storage Temperature	Tstg	-40	85	°C
Operating Case Temperature	Tc	-5	80	°C
Relative Humidity (No Condensation)	RH	0	85	%
Damage Threshold	THd	0		dBm
Link Distance Through Mux	D		20	km
Link Distance Back-to-Back	D		40	km

Electrical Characteristics

Parameter	Symbol	Min.	Typ.	Max.	Unit	Notes
Supply Voltage	Vcc	3.135	3.3	3.465	V	
Supply Current	Icc			1.8	A	
Power Consumption			4.7 at -5°C 4.4 at 25°C 5.2 at 80°C	5.0 at -5°C 4.8 at 25°C 5.5 at 80°C	W	
Transmitter High-Speed Electrical Characteristics						
Signaling Rate	Rate	25.78125 ± 100ppm			Gbps	
Input Differential Impedance	ZIN		100		Ω	
Differential Input Voltage Per Lane				900	mV	
Input Impedance Mismatch				10	%	
Input High Voltage	VIH	2		Vcc+0.3	V	
Input Low Voltage	VIL	-0.3		0.8	V	
Receiver High-Speed Electrical Characteristics						
Signaling Rate	Rate	25.78125 ± 100ppm			Gbps	
Common-Mode Voltage	Vcm	-350		2850	mV	
Common-Mode Noise (RMS)				17.5	mV	20-80%
Differential Termination Resistance Mismatch (At 1MHz)				10	%	
Differential Return Loss (SDD22)				Per CEI-28G-VSR	dB	
Common-Mode to Differential Conversion and Differential to Common-Mode Conversion (SDC22, SCD22)				Per CEI-28G-VSR	dB	
Common-Mode Return Loss (SCC22): From 250MHz to 30GHz				-2		

Transition Time (20-80%)		9.5			ps	
Vertical Eye Closure	VEC			6.5	dB	
Eye Width at 10 ⁻¹⁵ Probability	EW15	0.57			UI	
Eye Height at 10 ⁻¹⁵ Probability	EH15	228			mV	

Optical Characteristics (EOL)

Parameter	Symbol	Min.	Typ.	Max.	Unit	Notes
Transmitter						
Data Rate Per Lane		53.125 ± 100ppm			Gbps	
Modulation Format		PAM4				
Wavelength	λ	1301.91	1302.31	1302.71	nm	
Side-Mode Suppression Ratio	SMSR	30			dB	
Average Launch Power	Pavg	0		3.4	dBm	1
Outer Optical Modulation Amplitude (OMA _{outer})	TDP<1.4dB	POMA	3.0	6.4	dBm	
	TDP>1.4dB		1.6+TDP	6.4	dBm	
Transmitter and Dispersion Penalty	TDP			3.4	dB	
TECQ	TECQ			3.9	dB	
TDP-TECQ (Maximum)				2.5	dB	
Extinction Ratio	ER	5.0			dB	
Optical Return Loss Tolerance	ORLT			15.6	dB	
Transmitter Reflectance	RL			-26	dB	2
Average Launch Power Off Transmitter	Poff			-15	dBm	
RIN _{15.6OMA}	RIN			-136	dB/Hz	
Receiver						
Data Rate Per Lane		53.125 ± 100ppm			Gbps	
Modulation Format		PAM				
Lane Wavelength	λ	1295.04~1311.96			nm	
Damage Threshold	THd	0			dBm	3
Average Receive Power		-15.7		-3	dBm	4
Receive Power (OMA _{outer})				-2.6	dBm	
Receiver Reflectance	RL			-26	dB	
Receiver Sensitivity (OMA _{outer})					dBm	5, 6
Stressed Receiver Sensitivity (OMA _{outer}) Per Lane (Maximum)	SRS			-11.6	dBm	
Transmitter Reflectance	RL			-26	dB	
LOS Assert	LOSA	-30		-19.5	dBm	

LOS De-Assert	LOSD			-16.5	dBm	
LOS Hysteresis	LOSH	0.5			dB	
Conditions of Stress Receiver Sensitivity Test						
Stressed Eye Closure for PAM4 (SECQ) Lane Under Test				3.4	dB	
SECQ – $10 \cdot \log_{10}(\text{Ceq})$ Lane Under Test				3.4	dB	

Notes:

1. Average launch power (minimum) is informative and not the principal indicator of signal strength. A transmitter with launch power below this value cannot be compliant; however, a value above this does not ensure compliance.
2. Transmitter Reflectance is defined looking into the transmitter.
3. The receiver shall be able to tolerate, without damage, continuous exposure to a modulated optical input signal having this power level on one lane.
4. Average receive power (minimum) is informative and not the principal indicator of signal strength. A received power below this value cannot be compliant; however, a value above this does not ensure compliance.
5. Receiver Sensitivity (OMA_{outer}) (maximum) is informative and is defined for a transmitter with a value of SECQ up to 3.4dB for 100G ER1 O-Band WDM.
6. Measured with a conformance test signal at TP3 (see 3.11) for the BER specified in IEEE Std 802.3.

Pin Descriptions

Pin	Symbol	Name/Descriptions	Notes
1	GND	Transmitter Ground (Common with Receiver Ground).	1
2	Tx2-	Transmitter Inverted Data Input.	
3	Tx2+	Transmitter Non-Inverted Data Output.	
4	GND	Transmitter Ground (Common with Receiver Ground).	1
5	Tx4-	Transmitter Inverted Data Input.	
6	Tx4+	Transmitter Non-Inverted Data Output.	
7	GND	Transmitter Ground (Common with Receiver Ground).	1
8	ModSelL	Module Select.	2
9	ResetL	Module Reset.	2
10	VccRx	+3.3V Power Supply Receiver.	
11	SCL	2-Wire Serial Interface Clock.	2
12	SDA	2-Wire Serial Interface Data.	2
13	GND	Transmitter Ground (Common with Receiver Ground).	1
14	Rx3+	Receiver Non-Inverted Data Output.	
15	Rx3-	Receiver Inverted Data Output.	
16	GND	Transmitter Ground (Common with Receiver Ground).	1
17	Rx1+	Receiver Non-Inverted Data Output.	
18	Rx1-	Receiver Inverted Data Output.	
19	GND	Transmitter Ground (Common with Receiver Ground).	1
20	GND	Transmitter Ground (Common with Receiver Ground).	1
21	Rx2-	Receiver Inverted Data Output.	
22	Rx2+	Receiver Non-Inverted Data Output.	
23	GND	Transmitter Ground (Common with Receiver Ground).	1
24	Rx4-	Receiver Inverted Data Output.	1
25	Rx4+	Receiver Non-Inverted Data Output.	
26	GND	Transmitter Ground (Common with Receiver Ground).	1
27	ModPrsl	Module Present.	
28	IntL	Interrupt.	2
29	VccTx	+3.3V Power Supply Transmitter.	
30	Vcc1	+3.3V Power Supply.	
31	LPMODE	Low-Power Mode.	2
32	GND	Transmitter Ground (Common with Receiver Ground).	1
33	Tx3+	Transmitter Non-Inverted Data Input.	
34	Tx3-	Transmitter Inverted Data Output.	

35	GND	Transmitter Ground (Common with Receiver Ground).	1
36	Tx1+	Transmitter Non-Inverted Data Input.	
37	Tx1-	Transmitter Inverted Data Output.	
38	GND	Transmitter Ground (Common with Receiver Ground).	1

Notes:

1. The module signal grounds are isolated from the module case.
2. This is an open collector/drain output that, on the host board, requires a 4.7kΩ to 10kΩ pull-up resistor to Host_Vcc.

Electrical Pin-Out Details

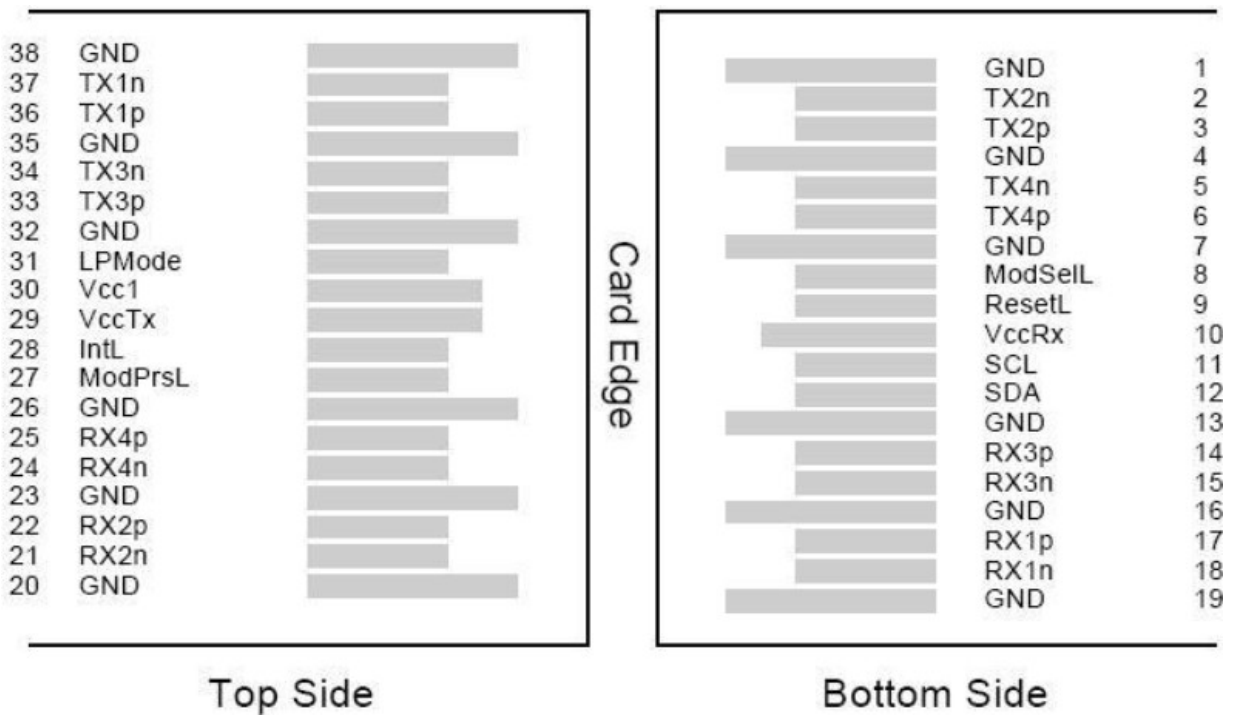

Recommended Host Board Power Supply Filter Network

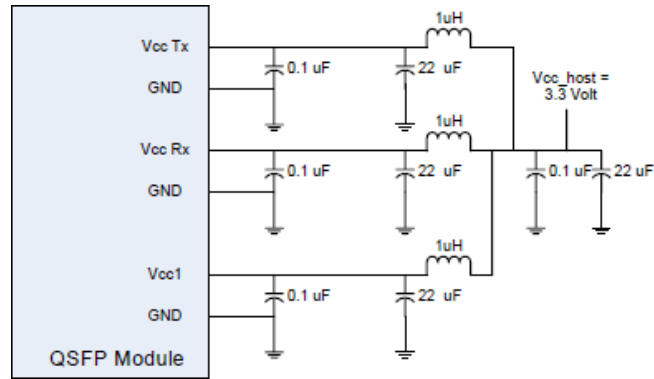

Block Diagram



Mechanical Specifications

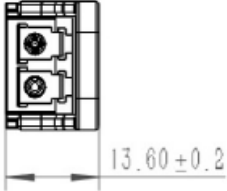
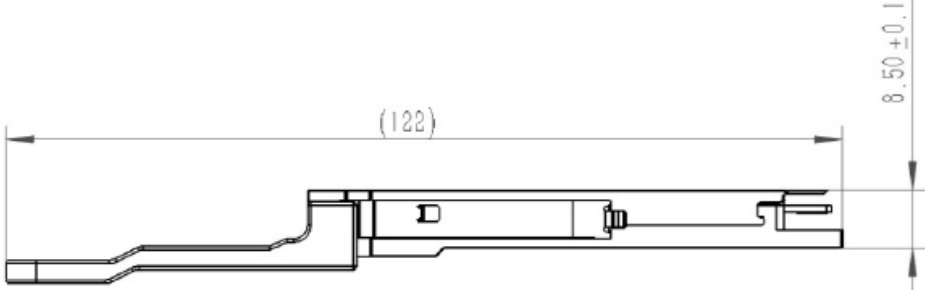
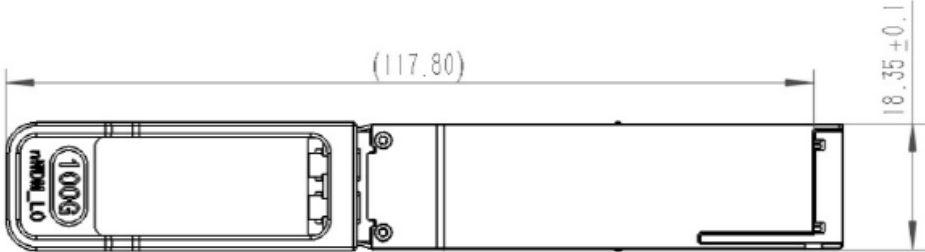

About Us:

Proline Options is one of North America's leading providers of transceivers and high speed cabling. With a reputation for quality, tested products that cover the connectivity spectrum, Proline Options has a solution for you regardless of the specification.

At Proline Options, every product is tested in its intended application - never batch or spec tested only. We run bandwidth, distance and IOS network tests. We have documented an impressive 0.03% failure rate over the last 10 years. To continue this rate of success we invest millions annually in our own on-site testing lab.



Tel: 855.933.3223

Email: sales@prolineoptions.com

Email: techsupport@prolineoptions.com

Web: <https://www.prolineoptions.com>