

QDD-400GB-ADAC8M-C-PRO

Cisco® Compatible TAA 400GBase-CU QSFP-DD to QSFP-DD Direct Attach Cable (Active Twinax, 8m)

Features

- Module Compliant to QSFP-DD MSA
- Low Power Consumption, Meeting 1.5W Module LP Mode
- Transmission Data Rate up to PAM4 53.125Gbps Per Channel
- Low Latency
- Supports Device Programming by MCU with I2C
- Enables a Transparent ACC Solution Meeting all IEEE 200GBASE-CR4 Auto-Negotiation and Link Training
- Operating Temperature: 0 to 70 Celsius
- Operates from a Single 3.3V Power Supply with an Integrated Power On Reset (POR)
- RoHS Compliant and Lead-Free



Applications:

- 400GBase Ethernet

Product Description

This is a Cisco® Compatible 400GBase-CU QSFP-DD to QSFP-DD direct attach cable that operates over active copper with a maximum reach of 8m. It has been programmed, uniquely serialized, and data-traffic and application tested to ensure it is 100% compliant and functional. We stand behind the quality of our products and proudly offer a limited lifetime warranty. This cable is TAA (Trade Agreements Act) compliant and is built to comply with MSA (Multi-Source Agreement) standards.

Proline's transceivers are RoHS compliant and lead-free.

TAA refers to the Trade Agreements Act (19 U.S.C. & 2501-2581), which is intended to foster fair and open international trade. TAA requires that the U.S. Government may acquire only "U.S. – made or designated country end products.



Absolute Maximum Ratings

Parameter	Symbol	Min.	Typ.	Max.	Unit	Notes
Supply Voltage	Vcc	-0.3	3.3	3.6	V	
Storage Temperature	Tstg	-40		85	°C	
Operating Case Temperature	Tc	0		70	°C	
Humidity	RH	5		85	%	
Data Rate			400		Gbps	

Physical Characteristics

Parameter	Symbol	Min.	Typ.	Max.	Unit	Notes
Length	L			8	M	
AWG			26		AWG	
Jacket Material		Plastic Braided Mesh, Orange				

Electrical Characteristics

Parameter	Symbol	Min.	Typ.	Max.	Unit	Notes
Input Amplitude		800		1200	mVp-p	
Control Logic Input Low Voltage	VIL	-0.3		0.35*Vcc	V	
Control Logic Input High Voltage	VIH	0.65* Vcc		Vcc+0.3	V	
Control Logic Input Low Current	IIL	-100		+100	uA	
Control Logic Input High Current	IIH	-100		+100	uA	
Output Logic Low	VOL			0.25* Vcc	V	
I2C Master Mode Output Frequency				400	kHz	

High-Speed Specifications

Parameter	Symbol	Min.	Typ.	Max.	Unit	Notes
Raw Cable Differential Impedance	Zca	90		110	Ω	
PCBA Differential Impedance	Zpcb	85		115	Ω	
Maximum Insertion Loss at 13.28GHz	SDD21	8		17.16	dB	
Other SI Performance		Compliant with IEEE802.3cd&bj				
Minimum COM	COM	3			dB	
BER with FEC				2.4x10 ⁻⁴		

Pin Descriptions

Pin	Logic	Symbol	Name/Description	Plug Sequence
1		GND	Module Ground.	1B
2	CML-I	Tx2-	Transmitter Inverted Data Input.	3B
3	CML-I	Tx2+	Transmitter Non-Inverted Data Input.	3B
4		GND	Module Ground.	1B
5	CML-I	Tx4-	Transmitter Inverted Data Input.	3B
6	CML-I	Tx4+	Transmitter Non-Inverted Data Input.	3B
7		GND	Module Ground.	1B
8	LVTTL-I	ModSelL	Module Select.	3B
9	LVTTL-I	ResetL	Module Reset.	3B
10		VccRx	+3.3V Receiver Power Supply.	2B
11	LVC MOS-I/O	SCL	2-Wire Serial Interface Clock.	3B
12	LVC MOS-I/O	SDA	2-Wire Serial Interface Data.	3B
13		GND	Module Ground.	1B
14	CML-O	Rx3+	Receiver Non-Inverted Data Output.	3B
15	CML-O	Rx3-	Receiver Inverted Data Output.	3B
16		GND	Module Ground.	1B
17	CML-O	Rx1+	Receiver Non-Inverted Data Output.	3B
18	CML-O	Rx1-	Receiver Inverted Data Output.	3B
19		GND	Module Ground.	1B
20		GND	Module Ground.	1B
21	CML-O	Rx2-	Receiver Inverted Data Output.	3B
22	CML-O	Rx2+	Receiver Non-Inverted Data Output.	3B
23		GND	Module Ground.	1B
24	CML-O	Rx4-	Receiver Inverted Data Output.	3B
25	CML-O	Rx4+	Receiver Non-Inverted Data Output.	3B
26		GND	Module Ground.	1B
27	LVTTL-O	ModPrsL	Module Present.	3B
28	LVTTL-O	IntL	Interrupt.	3B
29		VccTx	+3.3V Transmitter Power Supply.	2B
30		Vcc1	+3.3V Power Supply.	2B
31	LVTTL-I	InitMode	Initialization Mode. In legacy QSFP applications, the InitMode pad is called LPMODE.	3B
32		GND	Module Ground.	1B
33	CML-I	Tx3+	Transmitter Non-Inverted Data Input.	3B
34	CML-I	Tx3-	Transmitter Inverted Data Input.	3B
35		GND	Module Ground.	1B
36	CML-I	Tx1+	Transmitter Non-Inverted Data Input.	3B
37	CML-I	Tx1-	Transmitter Inverted Data Input.	3B
38		GND	Module Ground.	1B

39		GND	Module Ground.	1A
40	CML-I	Tx6-	Transmitter Inverted Data Input.	3A
41	CML-I	Tx6+	Transmitter Non-Inverted Data Input.	3A
42		GND	Module Ground.	1A
43	CML-I	Tx8-	Transmitter Inverted Data Input.	3A
44	CML-I	Tx8+	Transmitter Non-Inverted Data Input.	3A
45		GND	Module Ground.	1A
46		Reserved	For Future Use.	3A
47		VS1	Module Vendor-Specific 1.	3A
48		VccRx1	+3.3V Receiver Power Supply.	2A
49		VS2	Module Vendor-Specific 2.	3A
50		VS3	Module Vendor-Specific 3.	3A
51		GND	Module Ground.	1A
52	CML-O	Rx7+	Receiver Non-Inverted Data Output.	3A
53	CML-O	Rx7-	Receiver Inverted Data Output.	3A
54		GND	Module Ground.	1A
55	CML-O	Rx5+	Receiver Non-Inverted Data Output.	3A
56	CML-O	Rx5-	Receiver Inverted Data Output.	3A
57		GND	Module Ground.	1A
58		GND	Module Ground.	1A
59	CML-O	Rx6-	Receiver Inverted Data Output.	3A
60	CML-O	Rx6+	Receiver Non-Inverted Data Output.	3A
61		GND	Module Ground.	1A
62	CML-O	Rx8-	Receiver Inverted Data Output.	3A
63	CML-O	Rx8+	Receiver Non-Inverted Data Output.	3A
64		GND	Module Ground.	1A
64		NC	Not Connected.	3A
66		Reserved	For Future Use.	3A
67		VccTx1	+3.3V Transmitter Power Supply.	2A
68		Vcc2	+3.3V Power Supply.	2A
69		Reserved	For Future Use.	3A
70		GND	Module Ground.	1A
71	CML-I	Tx7+	Transmitter Non-Inverted Data Input.	3A
72	CML-I	Tx7-	Transmitter Inverted Data Input.	3A
73		GND	Module Ground.	1A
74	CML-I	Tx5+	Transmitter Non-Inverted Data Input.	3A
75	CML-I	Tx5-	Transmitter Inverted Data Input.	3A
76		GND	Module Ground.	1A

Electrical Pin-Out Details

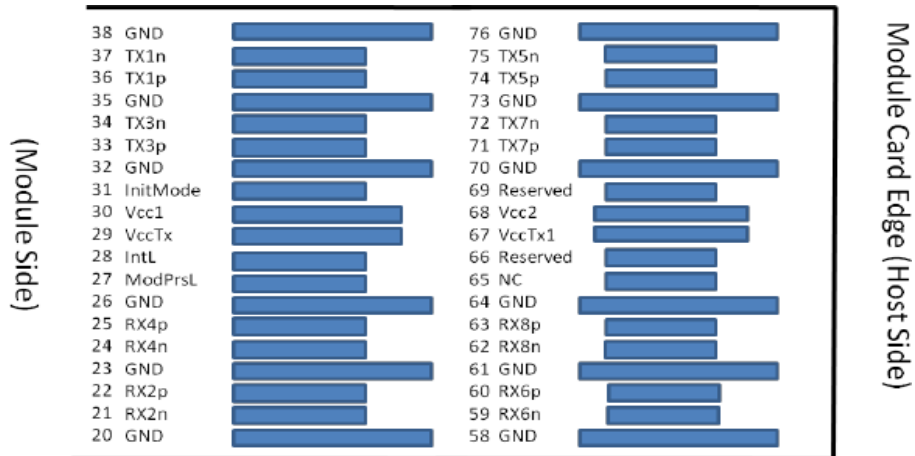

Top side viewed from top

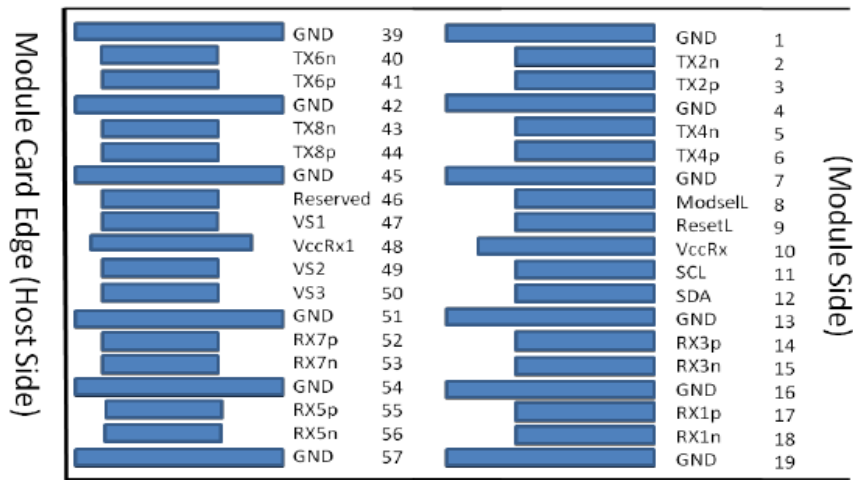

Bottom side viewed from bottom



Bending Radius

Wire Gauge	OD (Ref)	Minimum Bend Radius	Bend Space
26AWG	12.1mm	24.2mm	68mm

Block Diagram

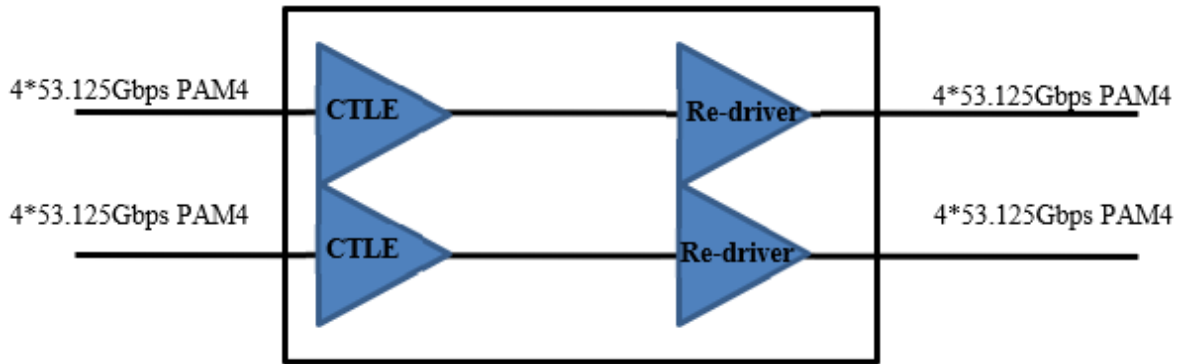

Wiring Table



Mechanical Specifications

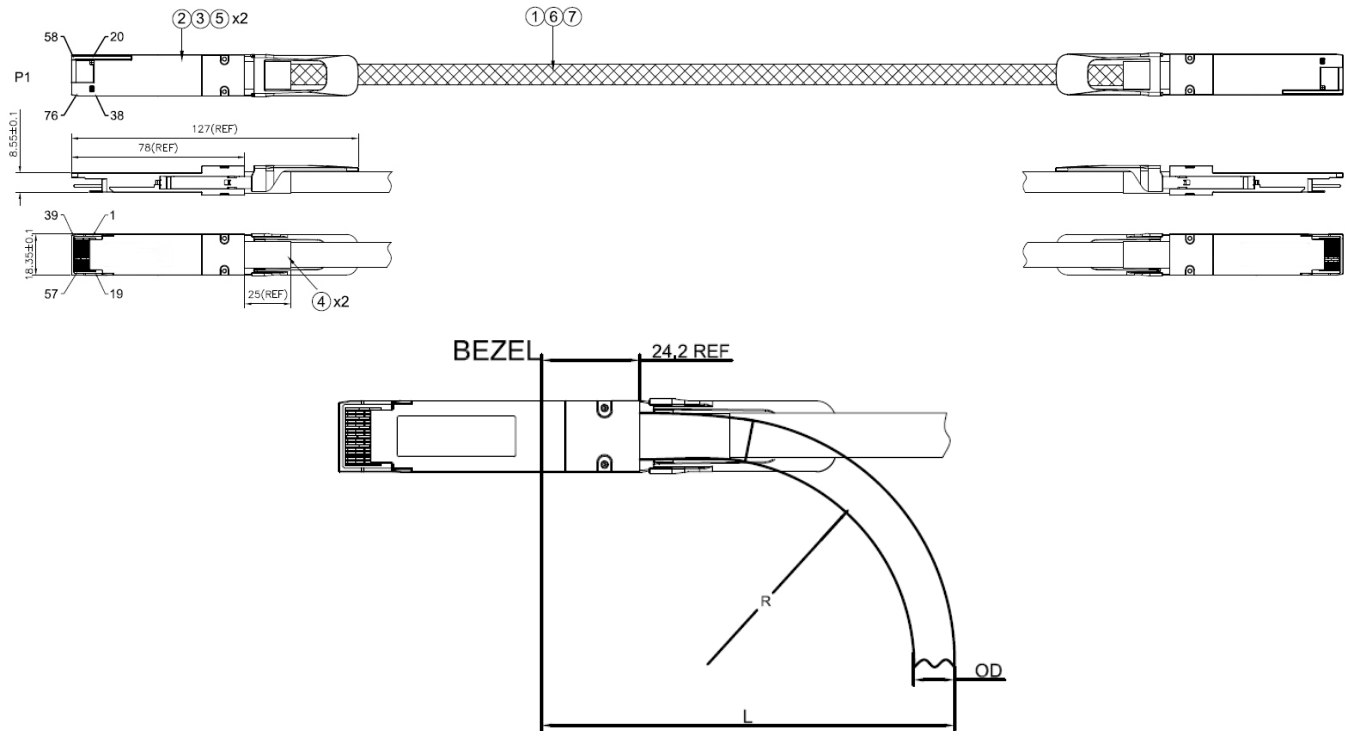

Item	Name	Description	Quantity
1	Raw Cable	SAS Cable, 56G, RoHS 2.0	A/R
2	PCBA	QSFP-DD PCBA with Signal Chip, 76 P, Gold 30u" Minimum	2
3	QSFP-DD Conn. Assembly	Zinc Alloy, Plated Nickel Over Copper + Stainless Steel Latch + Pull Tab	2
4	Heat Shrink Tube	Black	A/R
5	Back Shell Label	Black Shell Label, 29.5*10mm	2
6	Plastic Braided Mesh	Pet, Orange	A/R
7	Braid Shield	Copper, Braid	A/R

Notes:

- Raw cable impedance: $100 \pm 10 \Omega$.
Mated connector impedance: $100 \pm 15 \Omega$.
Rise time: 25ps (20-80%).
- High-frequency test according to IEEE802.3cd standard.
- All material must comply with RoHS 2.0.

About Us:

Proline Options is one of North America's leading providers of transceivers and high speed cabling. With a reputation for quality, tested products that cover the connectivity spectrum, Proline Options has a solution for you regardless of the specification.

At Proline Options, every product is tested in its intended application - never batch or spec tested only. We run bandwidth, distance and IOS network tests. We have documented an impressive 0.03% failure rate over the last 10 years. To continue this rate of success we invest millions annually in our own on-site testing lab.



Tel: 855.933.3223

Email: sales@prolineoptions.com

Email: techsupport@prolineoptions.com

Web: <https://www.prolineoptions.com>