

### MCP7F00-A003-PRO

Mellanox® MCP7F00-A003 Compatible TAA 100GBase-CU QSFP28 to 4xSFP28 Direct Attach Cable (Passive Twinax, 3m)

#### Features

- QSFP28 End: Compliant with QSFP28 MSA specifications
- 4 independent duplex channels operating at 25Gbps
- SFP28 End: Compliant with SFP28 MSA specifications
- 100 Ohm differential impedance
- All-metal housing for superior EMI performance
- AC coupled inputs and outputs
- Operating temperature range: 0 to 70 Celsius
- Single power supply 3.3V, low power consumption
- RoHS Compliant and Lead Free



#### Applications:

- 100Gigabit Ethernet
- Serial Data Transmission
- Infiniband EDR

#### Product Description

This is a Mellanox® MCP7F00-A003 Compatible 100GBase-CU QSFP28 to 4xSFP28 direct attach cable that operates over passive copper with a maximum reach of 3m. It has been programmed, uniquely serialized, and data-traffic and application tested to ensure it is 100% compliant and functional. We stand behind the quality of our products and proudly offer a limited lifetime warranty. This cable is TAA (Trade Agreements Act) compliant and is built to comply with MSA (Multi-Source Agreement) standards.

Proline's transceivers are RoHS compliant and lead-free.

TAA refers to the Trade Agreements Act (19 U.S.C. & 2501-2581), which is intended to foster fair and open international trade. TAA requires that the U.S. Government may acquire only "U.S. – made or designated country end products.



## General Specifications

| Parameter                  | Symbol | Min. | Typ. | Max.              | Unit  | Notes |
|----------------------------|--------|------|------|-------------------|-------|-------|
| Bit Error Rate             | BER    |      |      | 10 <sup>-12</sup> |       |       |
| Operating Temperature      | Tc     | 0    |      | 70                | °C    | 1     |
| Storage Temperature        | Tstg   | -40  |      | 85                | °C    | 2     |
| Input Voltage              | Vcc    | 3.14 | 3.3  | 3.46              | V     |       |
| Product Weight             | Gd     |      | 290  |                   | g/PCS |       |
| Cable Weight               | Gc     |      | 155  |                   | g/M   | 3     |
| SFP28 End Dust Cap Weight  | Gs     |      | 0.80 |                   | g/PCS |       |
| QSFP28 End Dust Cap Weight | Gq     |      | 1.40 |                   | g/PCS |       |
| Cable Impedance            | Z      | 90   | 100  | 110               | Ω     |       |

### Notes:

1. Case temperature.
2. Ambient temperature.
3. The weight of unit length cable (four sticks). For example, the weight of a 5m cable is 320+175\*(5-1)+0.80\*4+1.40=1024.6g.

## Cable Specifications

| Cable Length | Wire Gauge<br>AWG | Cable Diameter OD (mm) | Minimum Bending<br>Radius R (mm) | Insertion Loss Level |
|--------------|-------------------|------------------------|----------------------------------|----------------------|
| 3m           | 28AWG             | 5.0                    | 28                               | CA-25G-S             |

## QSFP28 Pin Descriptions

| Pin | Symbol  | Name/Description  | Notes |
|-----|---------|---|-------|
| 1   | GND     | Module Ground.  | 5     |
| 2   | Tx2-    | Transmitter Inverted Data Input. LAN2.  |       |
| 3   | Tx2+    | Transmitter Non-Inverted Data Input. LAN2.  |       |
| 4   | GND     | Module Ground.  | 5     |
| 5   | Tx4-    | Transmitter Inverted Data Input. LAN4.  |       |
| 6   | Tx4+    | Transmitter Non-Inverted Data Input. LAN4.  |       |
| 7   | GND     | Module Ground.  | 5     |
| 8   | ModselL | Module Select Pin. The module responds to 2-wire serial communication when low level. | 1     |
| 9   | ResetL  | Module Reset.   | 2     |
| 10  | VccRx   | +3.3V Receiver Power Supply.  |       |
| 11  | SCL     | 2-Wire Serial Interface Clock.  |       |
| 12  | SDA     | 2-Wire Serial Interface Data.   |       |
| 13  | GND     | Module Ground.  | 5     |
| 14  | Rx3+    | Receiver Non-Inverted Data Output. LAN3.  |       |
| 15  | Rx3-    | Receiver Inverted Data Output. LAN3.  |       |
| 16  | GND     | Module Ground.  | 5     |
| 17  | Rx1+    | Receiver Non-Inverted Data Output. LAN1.  |       |
| 18  | Rx1-    | Receiver Inverted Data Output. LAN1.  |       |
| 19  | GND     | Module Ground.  | 5     |
| 20  | GND     | Module Ground.  | 5     |
| 21  | Rx2-    | Receiver Inverted Data Output. LAN2.  |       |
| 22  | Rx2+    | Receiver Non-Inverted Data Output. LAN2.  |       |
| 23  | GND     | Module Ground.  | 5     |
| 24  | Rx4-    | Receiver Inverted Data Output. LAN4.  |       |
| 25  | Rx4+    | Receiver Non-Inverted Data Output. LAN4.  |       |
| 26  | GND     | Module Ground.  | 5     |
| 27  | ModPrsL | The module is inserted into the indicate pin and grounded within the module.          | 3     |
| 28  | IntL    | Interrupt.  | 4     |
| 29  | VccTx   | +3.3V Transmitter Power Supply.   |       |
| 30  | Vcc1    | +3.3V Power Supply.   |       |
| 31  | LPMODE  | Low-Power Mode.   | 5     |
| 32  | GND     | Module Ground.  | 5     |
| 33  | Tx3+    | Transmitter Non-Inverted Data Input. LAN3.  |       |
| 34  | Tx3-    | Transmitter Inverted Data Input. LAN3.  |       |

|    |      |  |   |
|----|------|--|---|
| 35 | GND  | Module Ground.                             | 5 |
| 36 | Tx1+ | Transmitter Non-Inverted Data Input. LAN1. |   |
| 37 | Tx1- | Transmitter Inverted Data Input. LAN1.     |   |
| 38 | GND  | Module Ground.                             | 5 |

**Notes:**

1. ModSelL is the input pin. The module responds to 2-wire serial communication commands when it is held "low" by the host. ModSelL allows multiple QSFP modules to be used on a single 2-wire interface bus. If ModSelL is "high," the module will not respond to any 2-wire interface communication from the host. ModSelL has internal pull-up resistors in the module.
2. The module restart pin, when the low level on the ResetL pin lasts longer than the minimum pulse length, resets the module and restores all user modules to their default state. When performing reset device, the host should ignore all status bits. Until the module reset interrupt is completed, please note that, during hot plugging, the module will issue this information to complete the reset interrupt without resetting.
3. This pin is active "high," indicating that the module is running under a low-power module. The signal has no effect on the functionality of this product.
4. IntL is the output pin, which is the open collector output and must be pulled up to Vcc with a 4.7kΩ to 10kΩ resistor on the motherboard. When it is "low," it indicates that the module may malfunction. The host uses a 2-wire serial interface to identify the interrupt source.
5. The circuit ground is internally isolated from the chassis ground.

### Electrical Pad Layout (QSFP28 End)

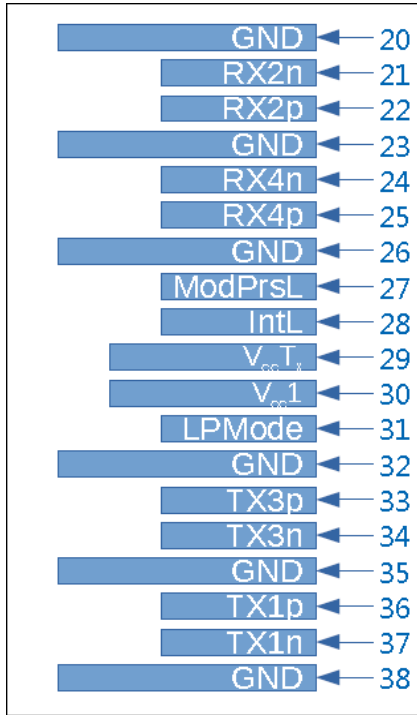

Top of Board

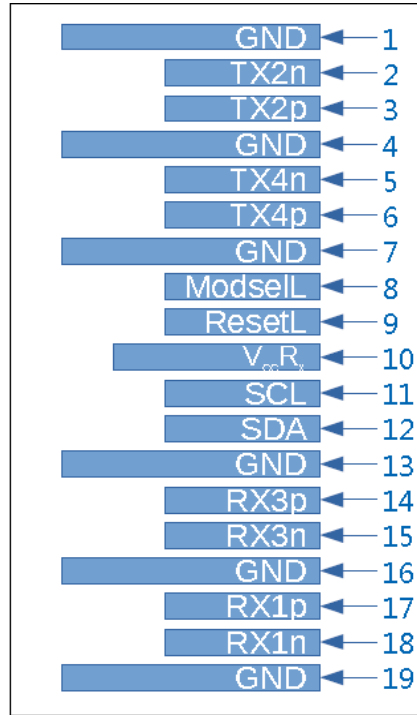

Bottom of Board

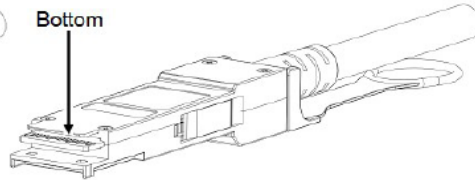
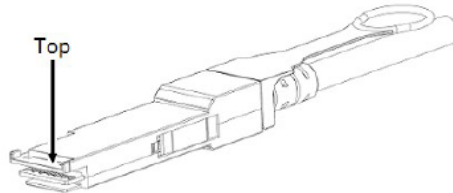

## SFP28 Pin Descriptions

| Pin | Symbol     | Name/Description   | Notes |
|-----|------------|--|-------|
| 1   | VeeT       | Transmitter Ground (Common with Receiver Ground).                                  |       |
| 2   | Tx_Fault   | Not Used. Transmitter Failure Alarm.   | 1     |
| 3   | Tx_Disable | Not Used. The signal turns off the module transmitter when it is “high” or “open.” | 2     |
| 4   | SDA        | Data Line for Serial ID.   |       |
| 5   | SCL        | Clock Line for Serial ID.  |       |
| 6   | MOD_ABS    | Module Absent. Grounded within the module.   |       |
| 7   | RS0        | No Connection Required.  | 1     |
| 8   | LOS        | Loss of Signal Indication. “Logic 0” indicates normal operation.                   | 2     |
| 9   | RS1        | No Connection Required.  | 1     |
| 10  | VeeR       | Receiver Ground (Common with Transmitter Ground).                                  |       |
| 11  | VeeR       | Receiver Ground (Common with Transmitter Ground).                                  |       |
| 12  | RD-        | Receiver Inverted Data Out. AC Coupled.  |       |
| 13  | RD+        | Receiver Non-Inverted Data Out. AC Coupled.  |       |
| 14  | VeeR       | Receiver Ground (Common with Transmitter Ground).                                  |       |
| 15  | VccR       | Receiver Power Supply.   |       |
| 16  | VccT       | Transmitter Power Supply.  |       |
| 17  | VeeT       | Transmitter Ground (Common with Receiver Ground).                                  |       |
| 18  | TD+        | Transmitter Non-Inverted Data In. AC Coupled.                                      |       |
| 19  | TD-        | Transmitter Inverted Data In. AC Coupled.  |       |
| 20  | VeeT       | Transmitter Ground (Common with Receiver Ground).                                  |       |

### Notes:

1. The circuit ground is isolated from the chassis ground.
2. Should be pulled up with 4.7k $\Omega$  to 10k $\Omega$  on the host board to a voltage between 2V and 3.6V.

### Electrical Pad Layout (SFP28 End)

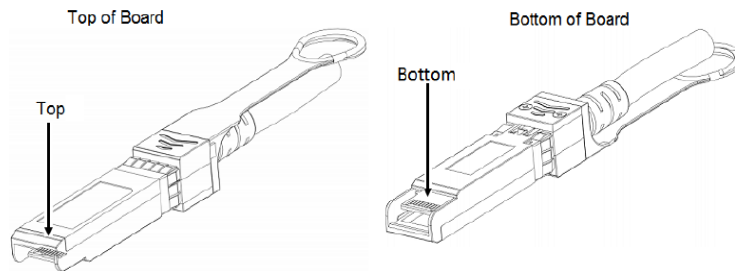
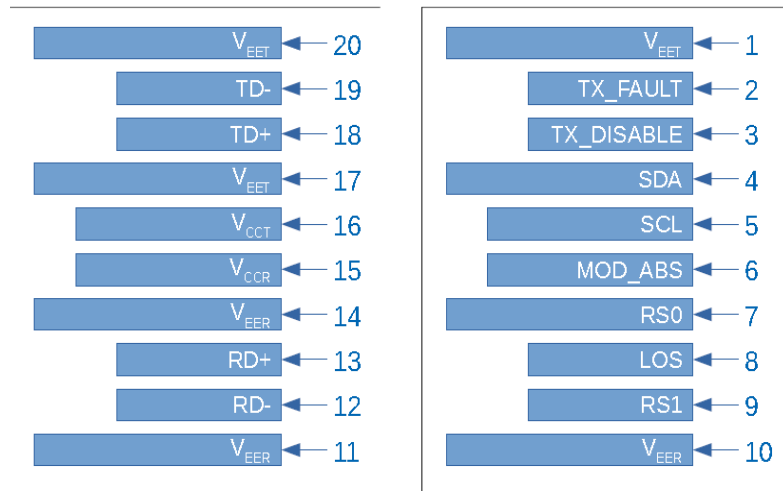

### Mechanical Dimensions

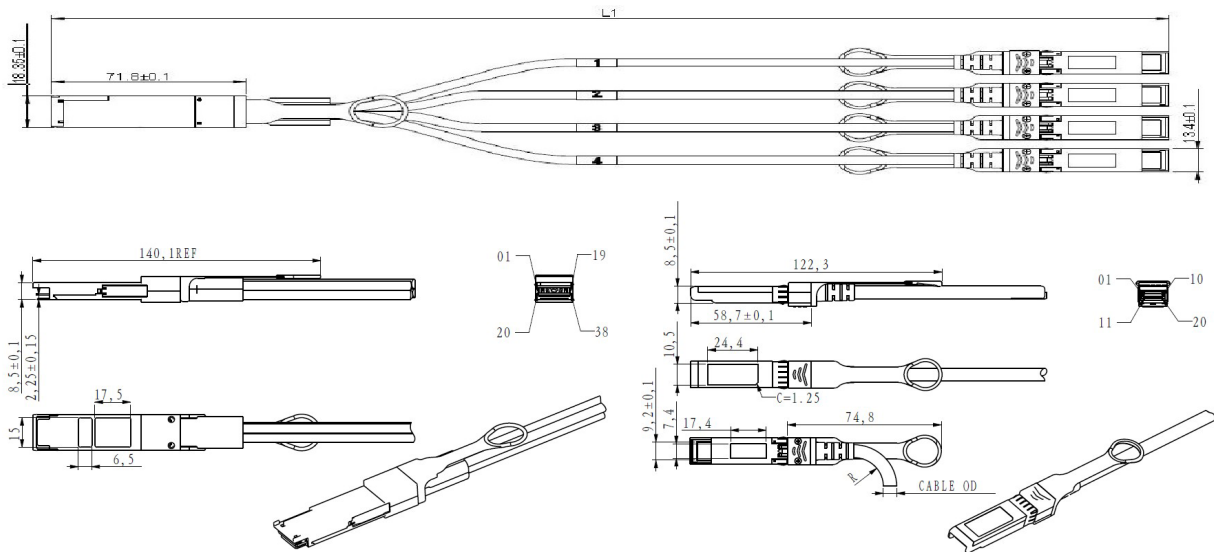

All Dimensions Are  $\pm 0.2$ mm Unless Otherwise Specified  
Unit: mm

**About Us:**

Proline Options is one of North America's leading providers of transceivers and high speed cabling. With a reputation for quality, tested products that cover the connectivity spectrum, Proline Options has a solution for you regardless of the specification.

At Proline Options, every product is tested in its intended application - never batch or spec tested only. We run bandwidth, distance and IOS network tests. We have documented an impressive 0.03% failure rate over the last 10 years. To continue this rate of success we invest millions annually in our own on-site testing lab.



Tel: 855.933.3223

Email: [sales@prolineoptions.com](mailto:sales@prolineoptions.com)

Email: [techsupport@prolineoptions.com](mailto:techsupport@prolineoptions.com)

Web: <https://www.prolineoptions.com>