

### JNP-SFP-25G-LR-CW-55-PRO

Juniper Networks® Compatible TAA Compliant 25GBase-CWDM SFP28 Transceiver (SMF, 1550nm, 10km, DOM, 0 to 70C, LC)

#### Features

- Up to 25.78Gbps bi-directional data links
- Built-in dual CDR with bypass function
- Electrical interface specifications per SFF-8431
- CWDM-rated EML Transmitter and APD Receiver
- Up to 10km on 9/125um SMF
- SFP28 MSA package with duplex LC connector
- Operating temperature: 0 to 70 Celsius
- Single +3.3V power supply
- 1.8W maximum power consumption
- SFF-8432 and SFF-8472 Compliance
- Class 1 Laser Safety Certified
- RoHS compliant and lead-free



#### Applications:

- 25x Gigabit Ethernet over CWDM
- Access, Metro and Enterprise
- Mobile Fronthaul CPRI/OBSAI

#### Product Description

This Juniper Networks® SFP28 transceiver provides 25GBase-CWDM throughput up to 10km over single-mode fiber (SMF) using a wavelength of 1550nm via an LC connector. It is guaranteed to be 100% compatible with the equivalent Juniper Networks® transceiver. This easy to install, hot swappable transceiver has been programmed, uniquely serialized and data-traffic and application tested to ensure that it will initialize and perform identically. Digital optical monitoring (DOM) support is also present to allow access to real-time operating parameters. This transceiver is Trade Agreements Act (TAA) compliant. We stand behind the quality of our products and proudly offer a limited lifetime warranty.

Proline's transceivers are RoHS compliant and lead-free.

TAA refers to the Trade Agreements Act (19 U.S.C. & 2501-2581), which is intended to foster fair and open international trade. TAA requires that the U.S. Government may acquire only "U.S. – made or designated country end products.



## Regulatory Compliance

- ESD to the Electrical PINs: compatible with MIL-STD-883E Method 3015.4.
- ESD to the LC Receptacle: compatible with IEC 61000-4-3.
- EMI/EMC: compatible with FCC Part 15 Subpart B Rules, EN55022:2010.
- Laser Eye Safety: compatible with FDA 21CFR, EN60950-1& EN (IEC) 60825-1, 2.
- RoHS: compliant with EU RoHS 2.0 directive 2015/863/EU.

## CWDM Available Wavelengths

Wavelengths	Min.	Typ.	Max.
47	1464.5	1471	1477.5
49	1484.5	1491	1497.5
51	1504.5	1511	1517.5
53	1524.5	1531	1537.5
55	1544.5	1551	1557.5

## Absolute Maximum Ratings

Parameter	Symbol	Min.	Typ.	Max.	Unit	Notes
Maximum Supply Voltage	Vcc	-0.5		4.0	V	
Storage Temperature	Tstg	-40		85	°C	
Operating Case Temperature	Tc	0	25	70	°C	
Relative Humidity	RH	5		95	%	
Data Rate			24.33 25.78		Gbps	
Bit Error Rate	BER			$5 \times 10^{-5}$		1
Supported Link Length on 9/125µm SMF @ 25.78Gbps	L		10		km	2

## Notes:

1. Tested with a PRBS 2<sup>31</sup>-1 test pattern for 25.78Gbps operation.
2. Distances are based on FC-PI-6 Rev. 3.1 and IEEE 802.3 standards.

## Electrical Characteristics

Parameter	Symbol	Min.	Typ.	Max.	Unit	Notes	
Power Supply Voltage	V <sub>CC</sub>	3.135	3.3	3.465	V		
Power Supply Current	I <sub>CC</sub>			545	mA		
Power Dissipation	P <sub>D</sub>			1800	mW		
<b>Transmitter</b>							
Differential Input Impedance	Z <sub>IN</sub>		100		Ω		
Differential Data Input Swing	V <sub>IN,pp</sub>	180		700	mVp-p		
Tx_Fault	Transmitter Fault	V <sub>OH</sub>	2.0		Host_Vcc	V	
	Normal Operation	V <sub>OL</sub>	0		0.8	V	
Tx_Disable	Transmitter Disable	V <sub>IH</sub>	2.0		Host_Vcc	V	
	Transmitter Enable	V <sub>IL</sub>	0		0.8	V	
<b>Receiver</b>							
Differential Output Impedance	Z <sub>OUT</sub>		100		Ω		
Differential Data Output Swing	V <sub>OUT,pp</sub>	300		850	mVp-p	1	
Data Output Rise Time/Fall Time	T <sub>r</sub> /T <sub>f</sub>	15			ps	2	
Rx_LOS	Loss of Signal (LOS)	V <sub>OH</sub>	2.0		Host_Vcc	V	3
	Normal Operation	V <sub>OL</sub>	0		0.8	V	3

### Notes:

1. Internally AC coupled but requires an external 100Ω differential load termination.
2. 20–80 %.
3. LOS is an open collector output. Should be pulled up with 4.7kΩ on the host board.

## Optical Characteristics

Parameter	Symbol	Min.	Typ.	Max.	Unit	Notes
<b>Transmitter</b>						
Launch Optical Power	P <sub>o</sub>	0		5	dBm	1
Extinction Ratio	ER	4.5			dB	
Center Wavelength Range	λ <sub>C</sub>	1464.5		1557.5	nm	
Transmitter and Dispersion Penalty	TDP			4	dB	
Spectral Width	Δλ			1	nm	2
Optical Return Loss Tolerance	ORLT			21	dB	
Pout @Tx_Disable Asserted	P <sub>off</sub>			-30	dBm	
<b>Receiver</b>						
Center Wavelength	λ <sub>C</sub>	1460		1620	nm	
Receiver Sensitivity (Avg)	S			-19	dBm	1
Receiver Overload	P <sub>max</sub>	-4			dBm	
Optical Return Loss	ORL	26			dB	
LOS De-Assert	LOSD			-19	dBm	
LOS Assert	LOSA	-35			dBm	
LOS Hysteresis		0.5			dB	

### Notes:

1. Class 1 Laser Safety per FDA/CDRH and EN (IEC) 60825 regulations.
2. 20dB spectral width.
3. Measured with PRBS 2<sup>31</sup>-1 at 5×10<sup>-5</sup> BER.

## Pin Descriptions

Pin	Symbol	Name/Descriptions	Ref.
1	VeeT	Transmitter Ground (Common with Receiver Ground).	1
2	Tx_Fault	Transmitter Fault. LVTTTL-O.	2
3	Tx_Disable	Transmitter Disable. Laser output disabled on “high” or “open.” LVTTTL-I.	3
4	SDA	2-Wire Serial Interface Data. Same as MOD-DEF2 in INF-8074i. LVTTTL-I/O.	
5	SCL	2-Wire Serial Interface Data. Same as MOD-DEF2 in INF-8074i. LVTTTL-I.	
6	MOD_ABS	Module Absent. Connect to VeeT or VeeR in the module.	4
7	RS0	Rate Select 0. Not used.	5
8	LOS	Loss of Signal Indication. Logic 0 indicates normal operation. LVTTTL-O.	2
9	RS1	Rate Select 1. Not used.	5
10	VeeR	Receiver Ground (Common with Transmitter Ground).	1
11	VeeR	Receiver Ground (Common with Transmitter Ground).	1
12	RD-	Receiver Inverted Data Out. AC Coupled. CML-O.	
13	RD+	Receiver Non-Inverted Data Out. AC Coupled. CML-O.	
14	VeeR	Receiver Ground (Common with Transmitter Ground).	1
15	VccR	Receiver Power Supply.	
16	VccT	Transmitter Power Supply.	
17	VeeT	Transmitter Ground (Common with Receiver Ground).	1
18	TD+	Transmitter Non-Inverted Data In. AC Coupled. CML-I.	
19	TD-	Transmitter Inverted Data In. AC Coupled. CML-O.	
20	VeeT	Transmitter Ground (Common with Receiver Ground).	1

### Notes:

1. The module signal ground contacts, VeeR and VeeT, should be isolated from the module case.
2. This contact is an open collector/drain output and should be pulled up to the Host\_Vcc with the resistor in the range 4.7kΩ-10kΩ. Pull-ups can be connected to one or several power supplies; however, the host board design shall ensure that no module contract has voltage exceeding module VccT/R+0.5V.
3. Tx\_Disable is an input contact with a 4.7kΩ-10kΩ pull-up resistor to the VccT inside the module.
4. MOD\_ABS is connected to the VeeT or VeeR in the SFP+ module. The host may pull the contract up to Host\_Vcc with a resistor in the range from 4.7kΩ-10kΩ. MOD\_ABS is asserted “high” when the SFP+ module is physically absent from a host slot.
5. Internally pulled down per SFF-8431.



Pin-Out of Connector Block on the Host Board

**Recommended Host Board Power Supply Filter Network**

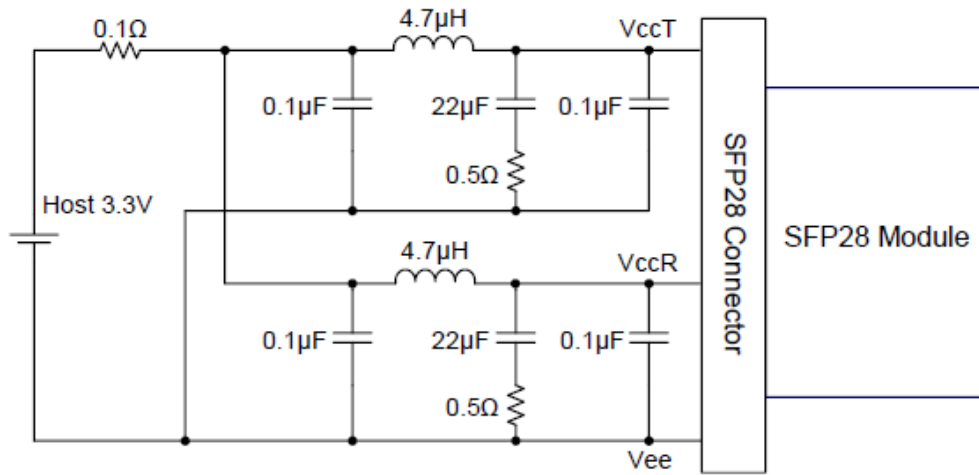

## Recommended Application Interface Block Diagram

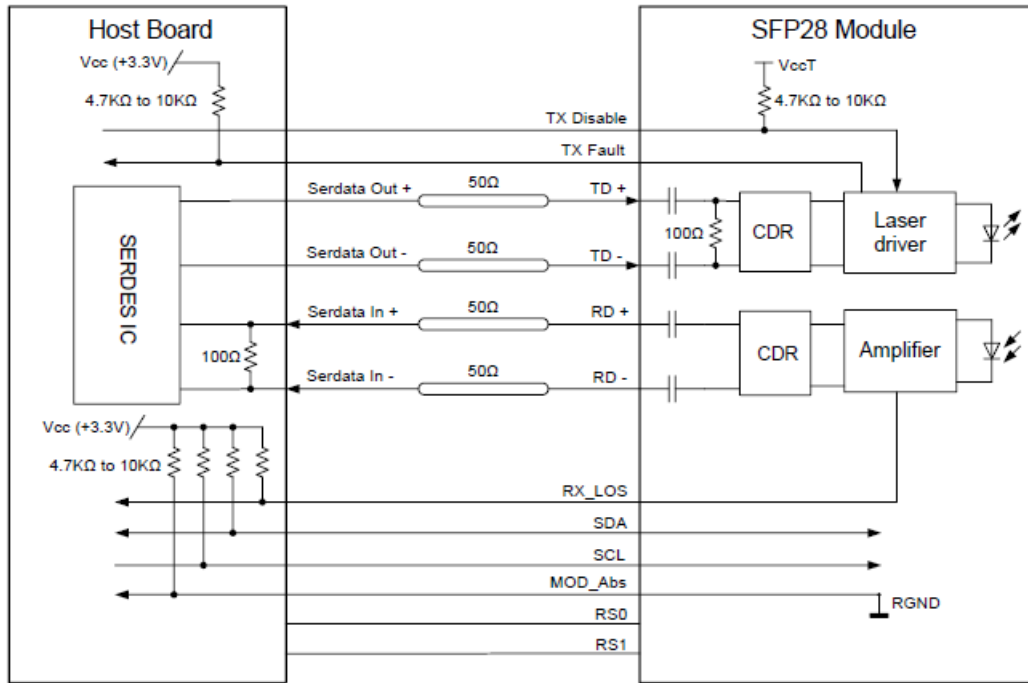

## Mechanical Specifications

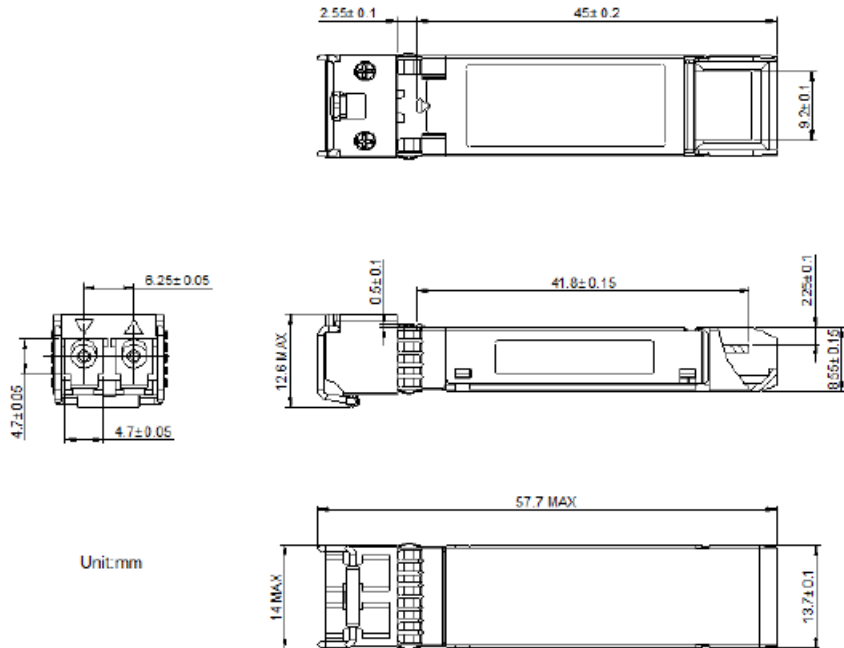

**About Us:**

Proline Options is one of North America's leading providers of transceivers and high speed cabling. With a reputation for quality, tested products that cover the connectivity spectrum, Proline Options has a solution for you regardless of the specification.

At Proline Options, every product is tested in its intended application - never batch or spec tested only. We run bandwidth, distance and IOS network tests. We have documented an impressive 0.03% failure rate over the last 10 years. To continue this rate of success we invest millions annually in our own on-site testing lab.



Tel: 855.933.3223

Email: [sales@prolineoptions.com](mailto:sales@prolineoptions.com)

Email: [techsupport@prolineoptions.com](mailto:techsupport@prolineoptions.com)

Web: <https://www.prolineoptions.com>