

JNP-SFP-25G-AOC-20M-PRO

Juniper Networks® JNP-SFP-25G-AOC-20M Compatible TAA 25GBase-AOC SFP28 to SFP28 Active Optical Cable (850nm, MMF, 20m)

Features

- Hot-pluggable SFP28 form factor
- 850nm VCSEL laser and PIN photo-detector
- Supports 25Gbps data rate
- Single 3.3V power supply
- Power dissipation < 1W
- Internal CDR on both Transmitter and receiver channel
- Operating Case temperature: 0 to 70 Celsius
- Digital diagnostics functions are available via the I2C interface
- RoHS Compliant and Lead-Free



Applications:

- 25Gbase-SR Ethernet

Product Description

This is a Juniper Networks® JNP-SFP-25G-AOC-20M Compatible 25GBase-AOC SFP28 to SFP28 active optical cable that operates over active fiber with a maximum reach of 20m. It has been programmed, uniquely serialized, and data-traffic and application tested to ensure it is 100% compliant and functional. We stand behind the quality of our products and proudly offer a limited lifetime warranty. This cable is TAA (Trade Agreements Act) compliant and is built to comply with MSA (Multi-Source Agreement) standards.

Proline's transceivers are RoHS compliant and lead-free.

TAA refers to the Trade Agreements Act (19 U.S.C. & 2501-2581), which is intended to foster fair and open international trade. TAA requires that the U.S. Government may acquire only "U.S. – made or designated country end products.



General Specifications

Parameter	Symbol	Min	Typ.	Max.	Unit
Storage Temperature		-40		85	°C
Operating Case Temperature	T _c	0		70	°C
Power Supply Voltage	V _{cc}	3.13	3.3	3.47	V
Supply Voltage	V _{cc}	0		3.6	V
Storage Temperature	T _{stg}	-40		85	°C
Operating Humidity		5		85	%

Optical Characteristics

Parameter	Symbol	Min.	Typ.	Max.	Unit	Notes
Transmitter						
Data Rate	BR		25.78		Gbps	
Centre Wavelength	λ _c	840	850	860	nm	
Spectral Width (-20dB)	σ			0.6	nm	
Average Output Power	P _{avg}	-8.4		2.4	dBm	
Optical Power OMA	P _{OMA}	-6.4		3	dBm	
Extinction Ratio	ER	2			dB	
Differential data input swing	V _{IN,PP}	40		1000	mV	
Input Differential Impedance	Z _{IN}	90	100	110	Ω	
TX Disable	Disable		2.0		V _{cc}	V
	Enable		0		0.8	V
TX Fault	Fault		2.0		V _{cc}	V
	Normal		0		0.8	V
Receiver						
Data Rate	BR		25.78		Gbps	
Centre Wavelength	λ _c	840	850	860	nm	
Receiver Sensitivity (OMA)	P _{sens}			-10	dBm	
Stressed Sensitivity (OMA)				-5.2	dBm	
Receiver Power (OMA)				3	dBm	
LOS De-Assert	LOS _D			-13	dBm	
LOS Assert	LOS _A	-30			dBm	
LOS Hysteresis		0.5			dB	
Differential data output swing	V _{out,PP}	500		1130	mV	
LOS	High		2.0		V _{cc}	V
	Low			0.8	V	V

Pin Descriptions

Pin	Logic	Symbol	Name/Description	Notes
1		VeeT	Transmitter Ground.	
2	LV-TTL-O	TX_Fault	N/A	1
3	LV-TTL-I	TX_DIS	Transmitter Disable.	
4	LV-TTL-I/O	SDA	2-Wire Serial Data.	
5	LV-TTL-I	SCL	2-Wire Serial Clock.	
6		MOD_DEF0	Module present, connect to VeeT.	
7	LV-TTL-I	RS0	N/A	1
8	LV-TTL-O	LOS	LOS of Signal.	
9	LV-TTL-I	RS1	N/A	1
10		VeeR	Receiver Ground.	
11		VeeR	Receiver Ground.	
12	CML-O	RD-	Receiver Data Inverted.	
13	CML-O	RD+	Receiver Data Non-inverted.	
14		VeeR	Receiver Ground.	
15		VccR	Receiver Supply +3.3V.	
16		VccT	Transmitter Supply +3.3V.	
17		VeeT	Transmitter Ground.	
18	CML-I	TD+	Transmitter Data Non-Inverted.	
19	CML_I	TD-	Transmitter Data Inverted.	
20		VeeT	Transmitter Ground.	

Note:

1. Signals not supported in SFP28 Copper pulled-down to VeeT with 30kΩ resistor.

Host Board

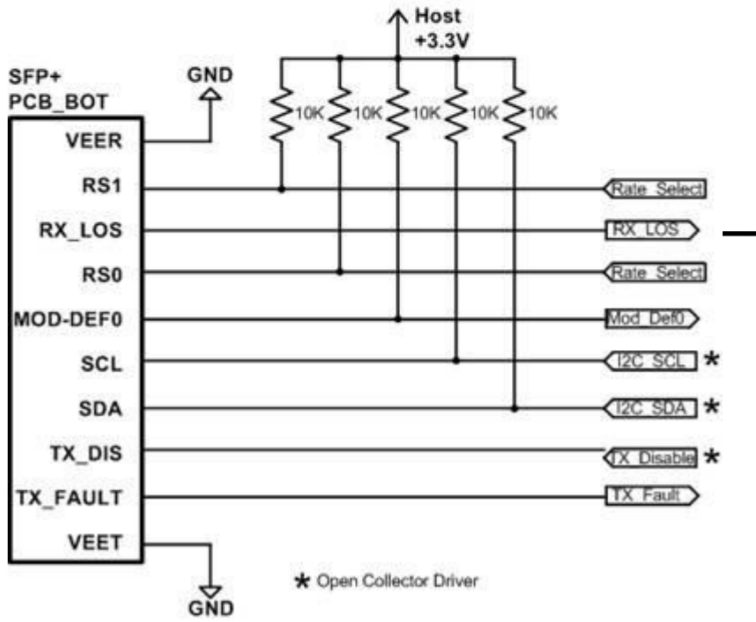
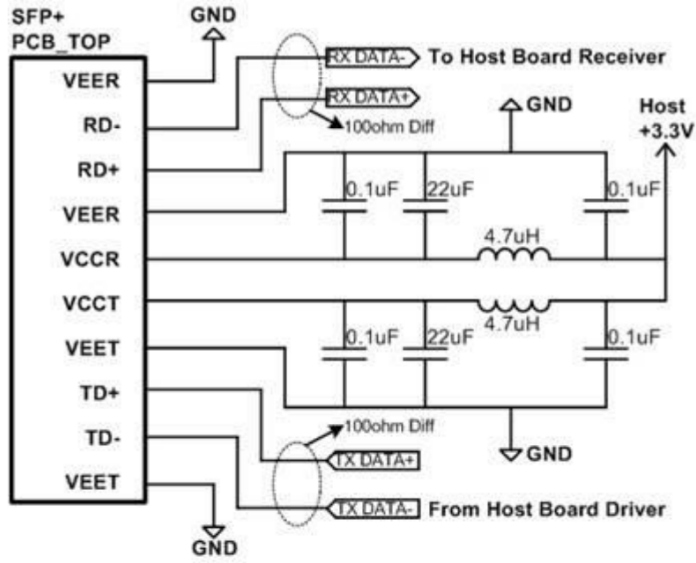

Mechanical Specification

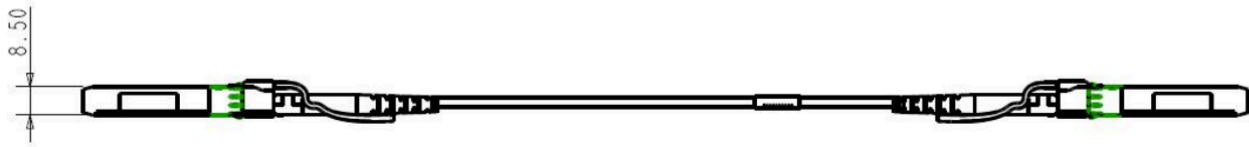
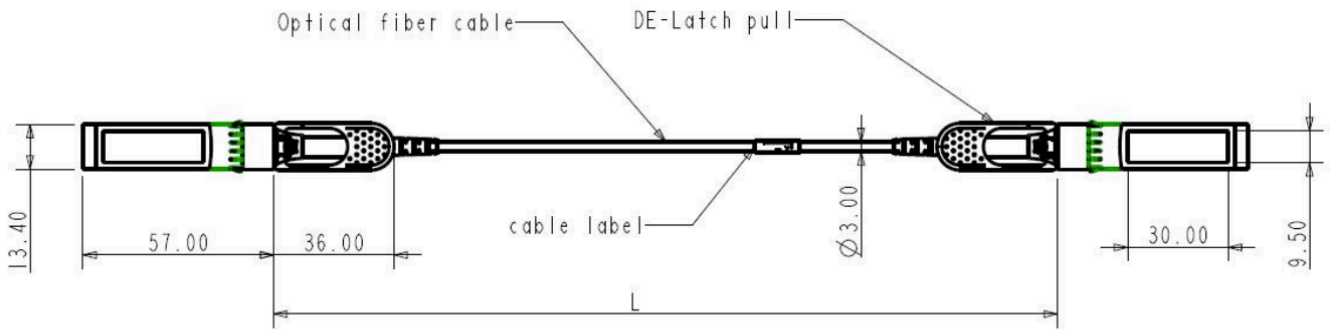

About Us:

Proline Options is one of North America's leading providers of transceivers and high speed cabling. With a reputation for quality, tested products that cover the connectivity spectrum, Proline Options has a solution for you regardless of the specification.

At Proline Options, every product is tested in its intended application - never batch or spec tested only. We run bandwidth, distance and IOS network tests. We have documented an impressive 0.03% failure rate over the last 10 years. To continue this rate of success we invest millions annually in our own on-site testing lab.



Tel: 855.933.3223

Email: sales@prolineoptions.com

Email: techsupport@prolineoptions.com

Web: <https://www.prolineoptions.com>