

JD063B-DW4135-160-PRO

HP® Compatible TAA Compliant 1000Base-DWDM 100GHz SFP Transceiver (SMF, 1541.35nm, 160km, DOM, 0 to 70C, LC)

Features

- Compliant with SFP MSA
- Single-mode Fiber
- Duplex LC Connector
- Hot Pluggable
- Metal with Lower EMI
- Single 3.3V Supply
- Commercial Temperature 0 to 70 Celsius
- Excellent ESD Protection
- RoHS Compliant and Lead Free



Applications:

- Gigabit Ethernet over DWDM
- Access and Enterprise

Product Description

This HP® SFP transceiver provides 1000Base-DWDM throughput up to 160km over single-mode fiber (SMF) using a wavelength of 1541.35nm via an LC connector. It is guaranteed to be 100% compatible with the equivalent HP® transceiver. This easy to install, hot swappable transceiver has been programmed, uniquely serialized and data-traffic and application tested to ensure that it will initialize and perform identically. Digital optical monitoring (DOM) support is also present to allow access to real-time operating parameters. This transceiver is Trade Agreements Act (TAA) compliant. We stand behind the quality of our products and proudly offer a limited lifetime warranty.

Proline's transceivers are RoHS compliant and lead-free.

TAA refers to the Trade Agreements Act (19 U.S.C. & 2501-2581), which is intended to foster fair and open international trade. TAA requires that the U.S. Government may acquire only "U.S. – made or designated country end products.



SFP+ Channel Number and Wavelength

Channel	Frequency	Center Wavelength (nm)	Channel	Frequency (THz)	Center Wavelength (nm)
0	190.0	1577.86	50	195.0	1537.40
1	190.1	1577.03	51	195.1	1536.61
2	190.2	1576.20	52	195.2	1535.82
3	190.3	1575.37	53	195.3	1535.04
4	190.4	1574.54	54	195.4	1534.25
5	190.5	1573.71	55	195.5	1533.47
6	190.6	1572.89	56	195.6	1532.68
7	190.7	1572.06	57	195.7	1531.90
8	190.8	1571.24	58	195.8	1531.12
9	190.9	1570.42	59	195.9	1530.33
10	191.0	1569.59	60	196.0	1529.55
11	191.1	1568.77	61	196.1	1528.77
12	191.2	1567.95	62	186.2	1610.06
13	191.3	1567.13	63	186.3	1609.19
14	191.4	1566.31	64	186.4	1608.33
15	191.5	1565.50	65	186.5	1607.47
16	191.6	1564.68	66	186.6	1606.60
17	191.7	1563.86	67	186.7	1605.74
18	191.8	1563.05	68	186.8	1604.88
19	191.9	1562.23	69	186.9	1604.03
20	192.0	1561.42	70	187.0	1603.17
21	192.1	1560.61	71	187.1	1602.31
22	192.2	1559.79	72	187.2	1601.46
23	192.3	1558.98	73	187.3	1600.60
24	192.4	1558.17	74	187.4	1599.75
25	192.5	1557.36	75	187.5	1598.89
26	192.6	1556.55	76	187.6	1598.04
27	192.7	1555.75	77	187.7	1597.19
28	192.8	1554.94	78	187.8	1596.34
29	192.9	1554.13	79	187.9	1595.49
30	193.0	1553.33	80	188.0	1594.64
31	193.1	1552.52	81	188.1	1593.79
32	193.2	1551.72	82	188.2	1592.95
33	193.3	1550.92	83	188.3	1592.10
34	193.4	1550.12	84	188.4	1591.26
35	193.5	1549.32	85	188.5	1590.41
36	193.6	1548.51	86	188.6	1589.57
37	193.7	1547.72	87	188.7	1588.73
38	193.8	1546.92	88	188.8	1587.88
39	193.9	1546.12	89	188.9	1587.04
40	194.0	1545.32	90	189.0	1586.20

41	194.1	1544.53	91	189.1	1585.36
42	194.2	1543.73	92	189.2	1584.53
43	194.3	1542.94	93	189.3	1583.69
44	194.4	1542.14	94	189.4	1582.85
45	194.5	1541.35	95	189.5	1582.02
46	194.6	1540.56	96	189.6	1581.18
47	194.7	1539.77	97	189.7	1580.35
48	194.8	1538.98	98	189.8	1579.52
49	194.9	1538.19	99	189.9	1578.69

Absolute Maximum Ratings

Parameter	Symbol	Min.	Typ.	Max.	Unit
Maximum Supply Voltage	Vcc	-0.5		3.6	V
Storage Temperature	Tstg	-40		85	°C
Operating Case Temperature	Tc	0		70	°C
Operating Humidity	RH			95	%
Data Rate	GBE		1.25		Gbps
	FC		1.063		

Electrical Characteristics

Parameter	Symbol	Min.	Typ.	Max.	Unit	Notes
Power Supply Voltage	Vcc	3.15	3.3	3.45	V	
Power Supply Current	Icc			450	mA	
Transmitter						
CML Differential Inputs	VIN	400		1600	mVp-p	AC Coupled Inputs
Input Differential Impedance	ZIN	85	100	115	Ω	RIN>100kΩ @ DC
Tx_Disable	Disable	2		Vcc	V	
	Enable	0		0.8		
Tx_Fault	Fault	2		Vcc	V	
	Normal	0		0.8		
Receiver						
CML Differential Outputs	VOUT	400	800	1200	mVp-p	AC Coupled Outputs
Output Impedance	ZOUT	85	100	115	Ω	
Rx_LOS	LOS	2		Vcc	V	
	Normal	0		0.8	V	
MOD-DEF (0:2)	VOH	2.5			V	
	VOL	0		0.8	V	

Optical Characteristics

Parameter	Symbol	Min.	Typ.	Max.	Unit	Notes
Transmitter						
Optical Center Wavelength	λ_C	1528		1610	nm	
Spectral Width (-20dB)	$\Delta\lambda$			0.3	nm	
Side-Mode Suppression Ratio	SMSR	30			dB	
Channel Spacing	Δf		100		GHz	
Deviation From Central Frequency @ EOL		-12		12	GHz	
Average Output Power	POUT	2		5	dBm	1
Average Launch Power (Tx Off)	Poff			-45	dBm	
Extinction Ratio	ER	8.2			dB	1
Rise/Fall Time (20-80%)	T_r/T_f			150	ps	
Tx_Disable Assert Time	Toff			10	us	
POUT @ Tx_Disable Asserted	POUT			-45	dBm	
Optical Signal Noise Ratio @ 0.1nm	OSNR		40		dB	3
Relative Intensity Noise	RIN			-135	dB/Hz	
Dispersion Tolerance	DT		2400		Ps/nm	
Output Optical Eye	Compatible with IEEE 802.3					1, 4
Receiver						
Optical Input Wavelength	λ	1528		1620	nm	
Receiver Sensitivity	Pmin			-31	dBm	2
Receiver Overload	Pmax	-9			dBm	
LOS De-Assert	LOSD			-32	dBm	
LOS Assert	LOSA	-45			dBm	
LOS Hysteresis			0.5		dB	5

Notes:

1. Filtered. Measured with a PRBS $2^{23}-1$ test pattern at 2.5Gbps.
2. Measured with a PRBS $2^{23}-1$ test pattern at 2.5Gbps, G.652 SMF, and BER $\leq 1 \times 10^{-12}$.
3. OSNR at BER of $10e^{-12}$.
4. Eye Pattern Mask.

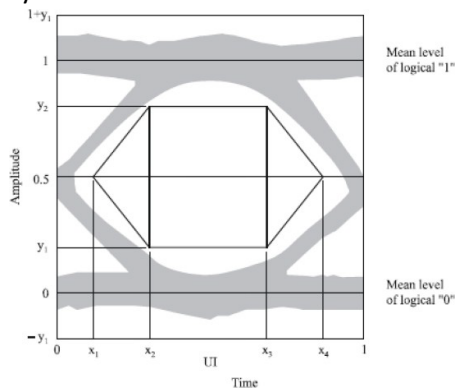

5. LOS Hysteresis.

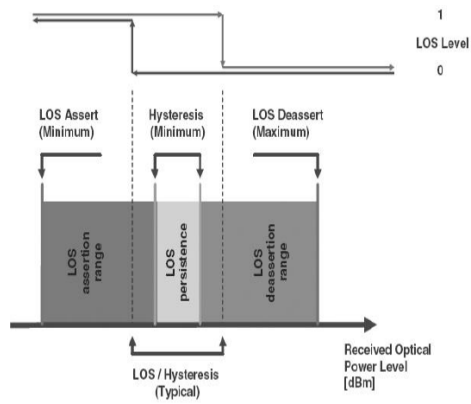

Pin Descriptions

Pin	Symbol	Name/Description	Note
1	VeeT	Transmitter Ground.	
2	Tx_Fault	Transmitter Fault Indication. Open Collector/Drain Output.	
3	Tx_Disable	Transmitter Disable.	
4	MOD-DEF2	Module Definition 2. 2-Wire Serial Interface Data.	
5	MOD-DEF1	Module Definition 1. 2-Wire Serial Interface Clock.	
6	MOD-DEF0	Module Definition 0. Grounded within the module.	
7	Rate Select	Rate Select 0. Not Used.	
8	LOS	Loss of Signal. Open Collector/Drain Output.	
9	VeeR	Receiver Ground.	
10	VeeR	Receiver Ground.	
11	VeeR	Receiver Ground.	
12	RD-	Inverted Receiver Data Out.	
13	RD+	Received Data Out.	
14	VeeR	Receiver Ground.	
15	VccR	Receiver Power. 3.3 ± 5%.	
16	VccT	Transmitter Power. 3.3 ± 5%.	
17	VeeT	Transmitter Ground.	
18	TD+	Transmitter Data In.	
19	TD-	Inverted Transmit Data In.	
20	VeeT	Transmitter Ground.	

Electrical Pad Layout

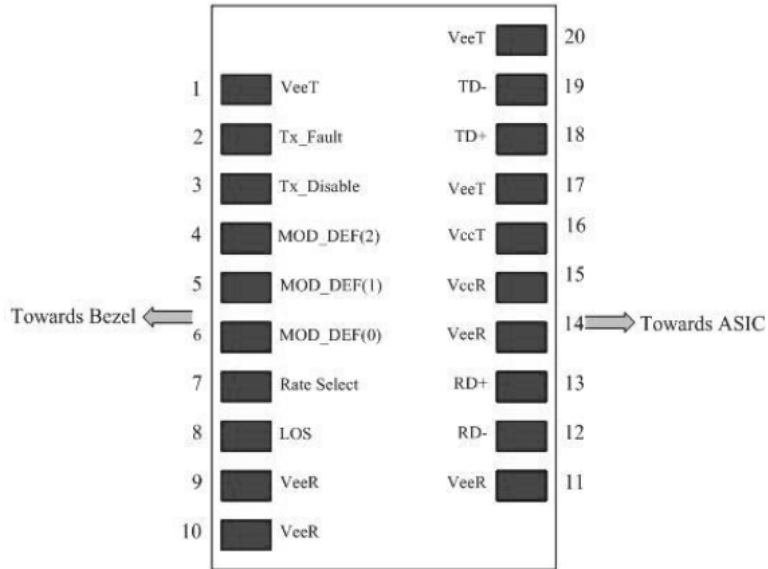
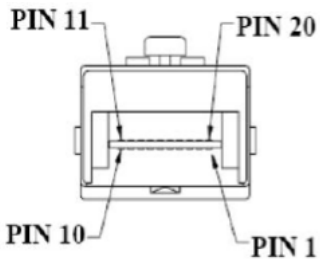

Recommended Circuit Schematic

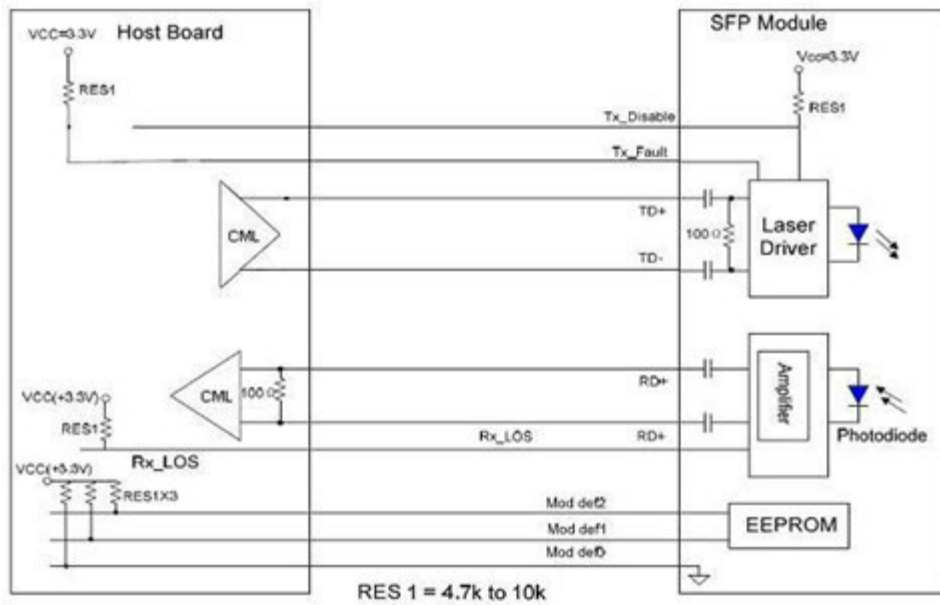

Functional Description of Transceiver

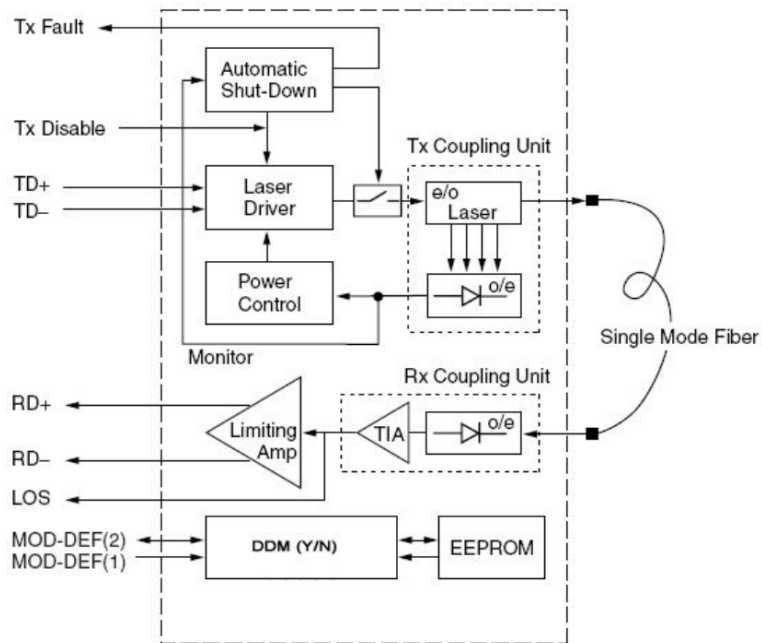

Mechanical Specifications

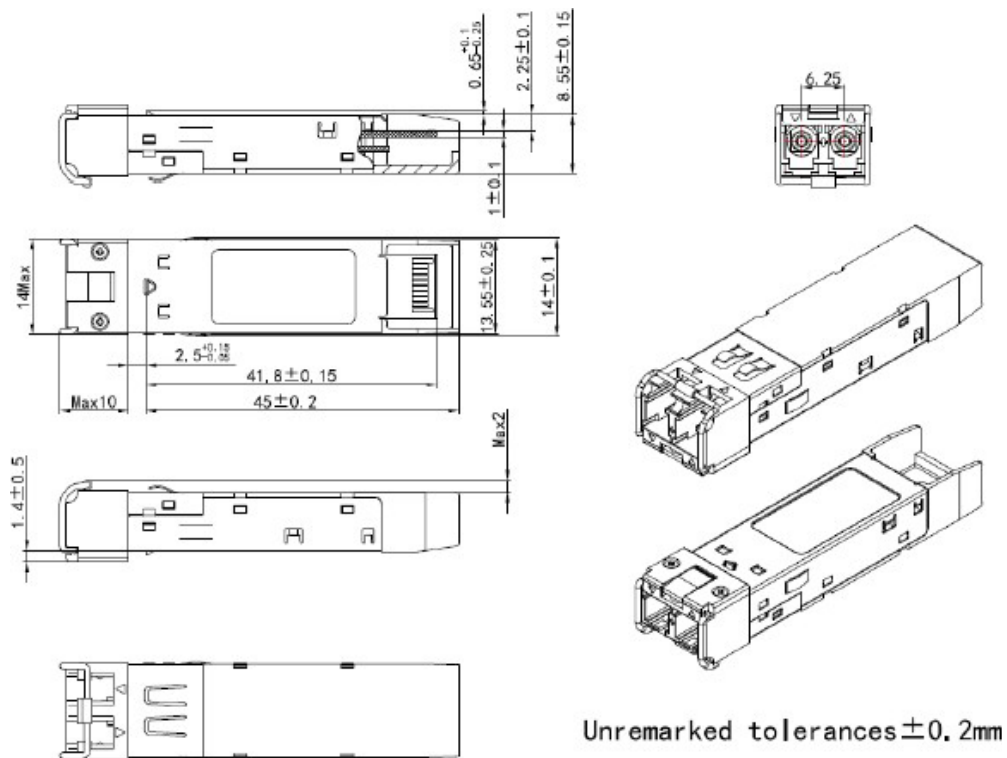

EEPROM Information

EEPROM memory map-specific data field description is as below:

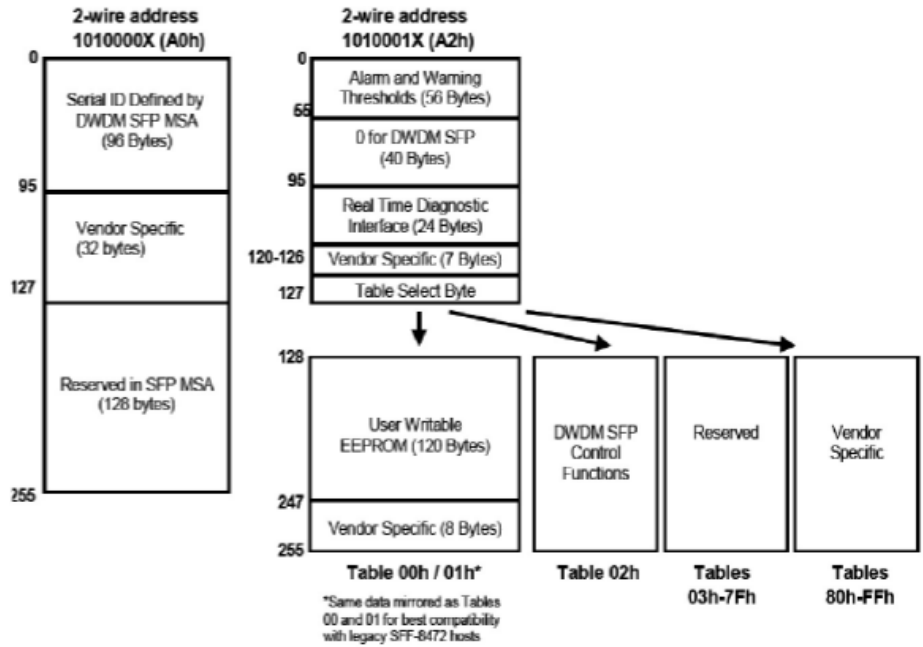

About Us:

Proline Options is one of North America's leading providers of transceivers and high speed cabling. With a reputation for quality, tested products that cover the connectivity spectrum, Proline Options has a solution for you regardless of the specification.

At Proline Options, every product is tested in its intended application - never batch or spec tested only. We run bandwidth, distance and IOS network tests. We have documented an impressive 0.03% failure rate over the last 10 years. To continue this rate of success we invest millions annually in our own on-site testing lab.



Tel: 855.933.3223

Email: sales@prolineoptions.com

Email: techsupport@prolineoptions.com

Web: <https://www.prolineoptions.com>