

CWDM-SFP25G-1350-10-PRO

Cisco® CWDM-SFP25G-1350-10 Compatible 25GBase-CWDM SFP28 Transceiver (SMF, 1350nm, 10km, DOM, 0 to 70C, LC)

Features

- SFF-8432 and SFF-8472 Compliance
- Duplex LC Connector
- Commercial Temperature 0 to 70 Celsius
- Single-mode Fiber
- Hot Pluggable
- Excellent ESD Protection
- Metal with Lower EMI
- RoHS Compliant and Lead Free



Applications:

- 25x Gigabit Ethernet over CWDM
- Access, Metro and Enterprise
- Mobile Fronthaul CPRI/OBSAI

Product Description

This Cisco® CWDM-SFP25G-1350-10 compatible SFP28 transceiver provides 25GBase-CWDM throughput up to 10km over single-mode fiber (SMF) using a wavelength of 1350nm via an LC connector. It is guaranteed to be 100% compatible with the equivalent Cisco® transceiver. This easy to install, hot swappable transceiver has been programmed, uniquely serialized and data-traffic and application tested to ensure that it will initialize and perform identically. Digital optical monitoring (DOM) support is also present to allow access to real-time operating parameters. We stand behind the quality of our products and proudly offer a limited lifetime warranty.

Proline's transceivers are RoHS compliant and lead-free.

TAA refers to the Trade Agreements Act (19 U.S.C. & 2501-2581), which is intended to foster fair and open international trade. TAA requires that the U.S. Government may acquire only "U.S. – made or designated country end products.

Regulatory Compliance

- ESD to the Electrical PINs: compatible with MIL-STD-883E Method 3015.4
- ESD to the LC Receptacle: compatible with IEC 61000-4-3
- EMI/EMC compatible with FCC Part 15 Subpart B Rules, EN55022:2010
- Laser Eye Safety compatible with FDA 21CFR, EN60950-1& EN (IEC) 60825-1,2
- RoHS compliant with EU RoHS 2.0 directive 2015/863/EU

Absolute Maximum Ratings

Parameter	Symbol	Min.	Typ.	Max.	Unit	Notes
Maximum Supply Voltage	Vcc	-0.5		4.0	V	1
Storage Temperature	Tstg	-40		85	°C	2
Operating Case Temperature	Tc	0		70	°C	3
Data Rate	DR		24.3	26.5	Gb/s	4
Bit Error Rate	BER			5×10 ⁻⁵		5

Notes:

1. For Electrical power interface.
2. Ambient Temperature.
3. Case Temperature.
4. IEEE 802.3cc.
5. Measured with data rate at 25.78GBps, PRBS 2³¹ – 1.

Electrical Characteristics

Parameter	Symbol	Min.	Typ.	Max.	Unit	Notes
Power Supply Voltage	Vcc	3.14	3.3	3.46	V	
Module Supply Current	Icc		220	450	mA	1
Transmitter						
Input Differential Impedance	RIN		100		Ω	
Differential Data Input Swing	VIN, pp	250		900	mV	
Transmit Disable Voltage	Vd	2		Vcc	V	
Transmit Enable Voltage	Ven	Vee		Vee+0.8	V	
Receiver						
Differential Data Output Swing	Vout_pp	300		850	mV	
LOS Assert	Vlos_a	2		Vcc_host	V	
LOS De-Assert	Vlos_d	Vee		Vee+0.8	V	

Notes:

1. For electrical power interface.

Optical Characteristics

Parameter	Symbol	Min.	Typ.	Max.	Unit	Notes
Transmitter						
Output Optical Power	Ptx	2	4.5	7	dBm	1
Optical Center Wavelength	λ_c	$\lambda_c - 6.5$	λ_c	$\lambda_c + 6.5$	nm	2
Transmitter and Dispersion Penalty	TDP			2.7	dB	
Extinction Ratio	ER	3.5			dB	
Spectral Width(-20dB)	$\Delta\lambda$			1	nm	
Side Mode Suppression Ratio	SMSR	30			dB	
Transmitter Reflectance				12	dB	
Launch Power of OFF Transmitter	Pout_off			-30	dBm	1
Receiver						
Optical Center Wavelength	λ_c	1260		1390	nm	
Receive Overload	Pol	2			dBm	
Receiver Sensitivity (OMA)@ 25.78 Gbps	Rx_sen			-13.3	dBm	3
Receiver Reflectance	TRrx			-26	dB	
LOS Assert	LOSA	-30			dBm	
LOS De-Assert	LOSD			-14	dBm	
LOS Hysteresis	LOSH	0.5			dB	

Notes:

1. Average.
2. $\lambda_c = 1271, 1291, 1311, 1331, 1351, 1371$.
3. Average optical power, measured with data rate at 25.78Gbps, PRBS $2^{31} - 1$.

Pin Descriptions

Pin	Symbol	Name/Descriptions	Notes
1	VeeT	Transmitter Ground. Common with receiver ground.	1
2	TX_Fault	Transmitter Fault.	2
3	TX_Disable	Transmitter Disable. Laser output disables on high or open.	3
4	SDA	Two wire serial interface Data Line.	4
5	SCL	Two wire serial interface Clock Line.	4
6	MOD_ABS	Module Absent. Grounded within the module.	4
7	RS0	No connection required.	
8	LOS	Loss of signal indication. Logic 0 indicated normal operation.	5
9	RS1	No connection required.	1
10	VeeR	Receiver Ground. Common with transmitter ground.	1
11	VeeR	Receiver Ground. Common with transmitter ground.	1
12	RD-	Receiver Inverted DATA out. AC coupled.	
13	RD+	Receiver Non-Inverted DATA out. AC coupled.	
14	VeeR	Receiver Ground. Common with transmitter ground.	1
15	VccR	Receiver power supply.	
16	VccT	Transmitter power supply.	
17	VeeT	Transmitter ground. Common with receiver ground.	1
18	TD+	Transmitter Non-Inverted Data in. AC coupled.	
19	TD-	Transmitter Inverted Data in. AC coupled.	
20	VeeT	Transmitter Ground. Common with receiver ground.	1

Notes:

1. Circuit ground is isolated from chassis ground.
2. TX_Fault is the open collector output and should be pulled up with 4.7k Ω -10k Ω on host board to a voltage between 2V and Vcc+0.3V.
3. Disables: T_{DIS}>2V or open, Enabled T_{DIS}<0.8V.
4. Should be pulled up with 4.7k Ω -10k Ω on host board to a voltage between 2V and Vcc+0.3V.
5. LOS is open collector output and should be pulled up with 4.7k Ω -10k Ω on host board to a voltage between 2V and Vcc0.3V, the logic "0" indicated normal operation, and the logic "1" indicates that the receiver signal is lost.

Block Diagram of Transceiver

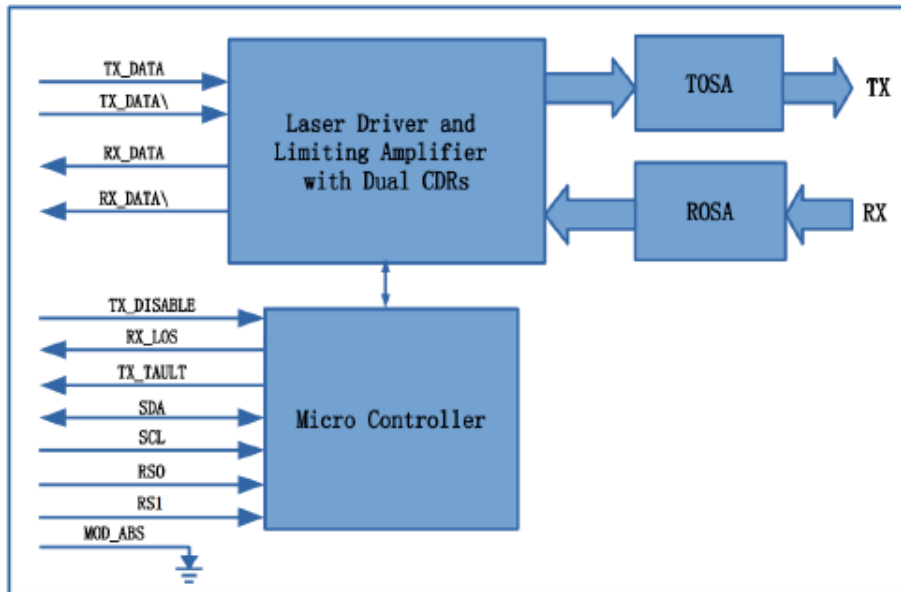

Electrical Pad Layout

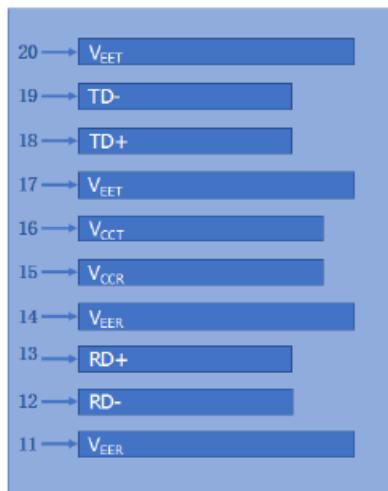

Top of Board

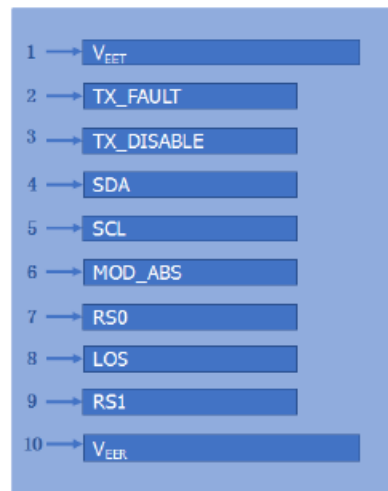
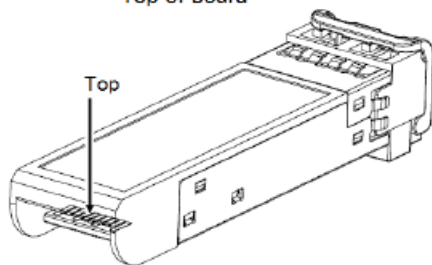

Bottom of Board

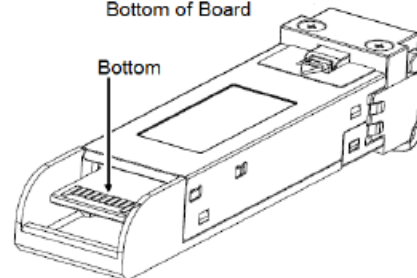

Mechanical Specifications

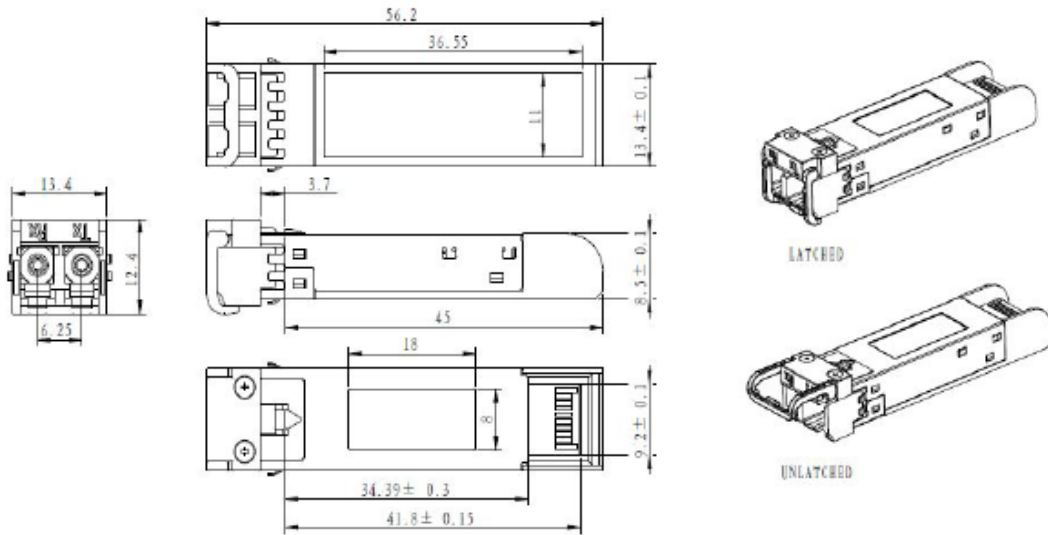

Typical Eye Diagram

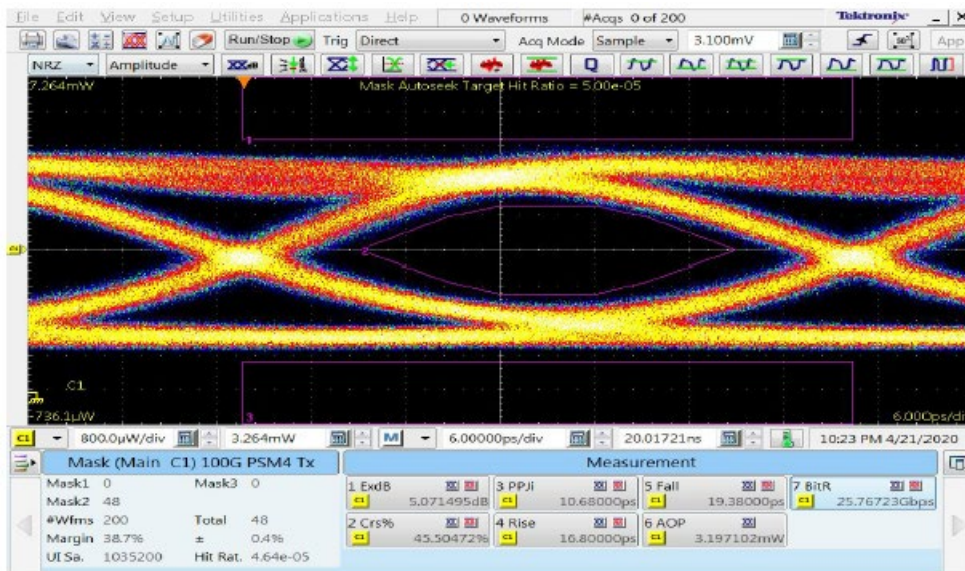

About Us:

Proline Options is one of North America's leading providers of transceivers and high speed cabling. With a reputation for quality, tested products that cover the connectivity spectrum, Proline Options has a solution for you regardless of the specification.

At Proline Options, every product is tested in its intended application - never batch or spec tested only. We run bandwidth, distance and IOS network tests. We have documented an impressive 0.03% failure rate over the last 10 years. To continue this rate of success we invest millions annually in our own on-site testing lab.



Tel: 855.933.3223

Email: sales@prolineoptions.com

Email: techsupport@prolineoptions.com

Web: <https://www.prolineoptions.com>