

10G-SFPP-TWX-0501-PRO

Brocade® (Formerly) 10G-SFPP-TWX-0501 Compatible TAA 10GBase-CU SFP+ to SFP+ Direct Attach Cable (Active Twinax, 5m, 30AWG)

Features

- Up to 10Gbps bi-directional data links
- Industry Standard small form pluggable
- Dual SFP Connectors
- Single Power Supply 3.3V
- Operating Temperature: 0 to 70 Celsius
- Hot Pluggable
- RoHS Compliant and Lead-Free



Applications:

- 10G Ethernet
- 10G Fibre Channel

Product Description

This is a Brocade® (Formerly) 10G-SFPP-TWX-0501 Compatible 10GBase-CU SFP+ to SFP+ direct attach cable that operates over active copper with a maximum reach of 5m. It has been programmed, uniquely serialized, and data-traffic and application tested to ensure it is 100% compliant and functional. We stand behind the quality of our products and proudly offer a limited lifetime warranty. This cable is TAA (Trade Agreements Act) compliant and is built to comply with MSA (Multi-Source Agreement) standards.

Proline's transceivers are RoHS compliant and lead-free.

TAA refers to the Trade Agreements Act (19 U.S.C. & 2501-2581), which is intended to foster fair and open international trade. TAA requires that the U.S. Government may acquire only "U.S. – made or designated country end products.



General Specifications

Parameter	Symbol	Min	Typ.	Max.	Unit	Notes
Data Rate	DR		10.3125		Gbps	1
Bit Error Rate	BER			10 ⁻¹²		
Operating Case Temperature	T _c	0		70	°C	2
Storage Temperature	T _{stg}	-40		85	°C	3
Input Voltage	V _{cc}	3.14	3.3	3.46	V	4
Supply Current	I _{cc}		100	300	mA	4
Cable Impedance	Z	90	100	110	Ω	
Product Weight	GD		72		g/PCS	
Cable Weight	GC		26		G/M	
Dust Cap Weight	GS		0.80		g/PCS	
Wire Gauge			30		AWG	
Tolerance Range			6		±cm	

Notes:

1. IEEE 802.3ae compatible.
2. Case temperature.
3. Ambient temperature.
4. For electrical power interface.

Pin Descriptions

Pin	Symbol	Name/Description	Notes
1	VeeT	Transmitter ground. Common with receiver ground.	1
2	Tx_Fault	Transmitter Fault.	
3	Tx_Disable	Transmitter Disable. Laser output disabled on "high" or "open."	2
4	SDA	Data line for Serial ID.	3
5	SCL	Clock line for Serial ID.	3
6	MOD_ABS	Module absent. Grounded within the module.	3
7	RS0	No connection required.	
8	LOS	Loss of Signal. Logic 0 indicated normal operation.	4
9	RS1	No connection required.	
10	VeeR	Receiver ground. Common with transmitter ground.	1
11	VeeR	Receiver ground. Common with transmitter ground.	1
12	RD-	Receiver Inverted DATA out. AC coupled.	
13	RD+	Receiver NonInverted DATA out. AC coupled.	
14	VeeR	Receiver ground. Common with transmitter ground.	1
15	VccR	Receiver power supply.	
16	VccT	Transmitter power supply.	
17	VeeT	Transmitter ground. Common with receiver ground.	1
18	TD+	Transmitter Non-Inverted DATA in. AC coupled.	
19	TD-	Transmitter Inverted DATA in. AC coupled.	
20	VeeT	Transmitter ground. Common with receiver ground.	1

Notes:

1. Circuit ground is isolated from chassis ground.
2. Disabled: Tdis>2V or open, Enabled Tdis<0.8V.
3. Should be pulled up with 4.7kΩ-10kΩ on host board to a voltage between 2V and 3.6V.
4. LOS is open collector output.

Electrical Pad Layout



Block Diagram



Mechanical Specifications

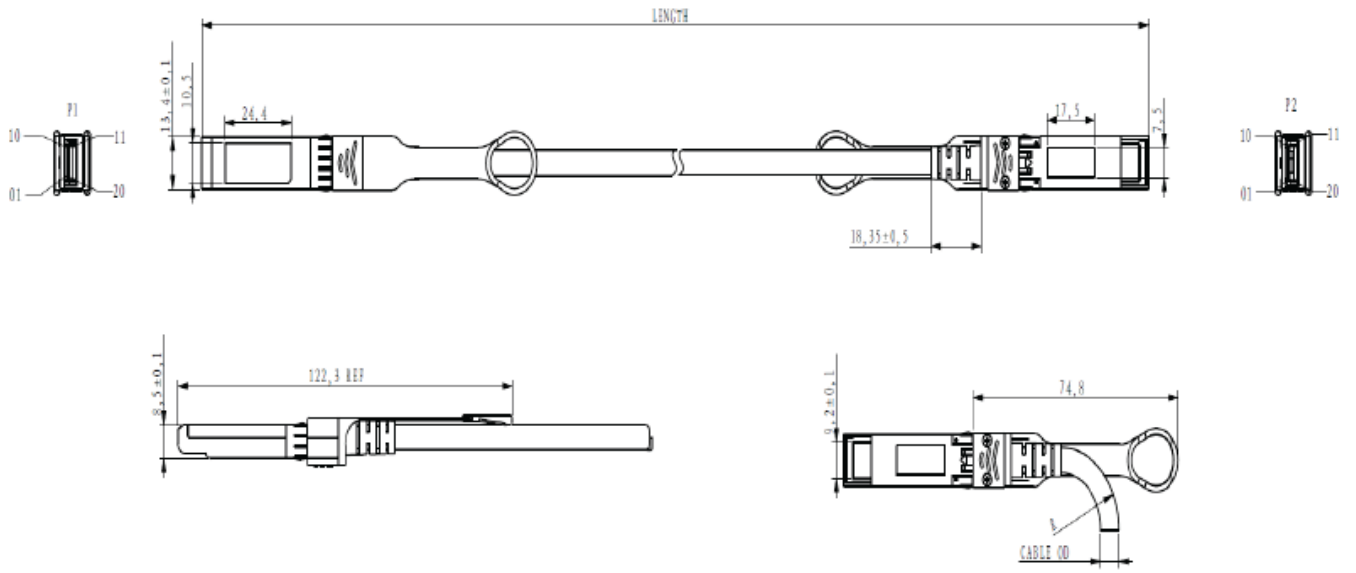

About Us:

Proline Options is one of North America's leading providers of transceivers and high speed cabling. With a reputation for quality, tested products that cover the connectivity spectrum, Proline Options has a solution for you regardless of the specification.

At Proline Options, every product is tested in its intended application - never batch or spec tested only. We run bandwidth, distance and IOS network tests. We have documented an impressive 0.03% failure rate over the last 10 years. To continue this rate of success we invest millions annually in our own on-site testing lab.



Tel: 855.933.3223

Email: sales@prolineoptions.com

Email: techsupport@prolineoptions.com

Web: <https://www.prolineoptions.com>